



SWISS  TOOLS[®]

S W I S S
FLEX
2301



PWLN
Seite/page 7



SVJB SVJC
Seite/page 11

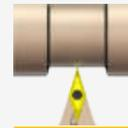

SVVB SVVC
Seite/page 17



SCLC
Seite/page 7



SVPB SVJC
Seite/page 12

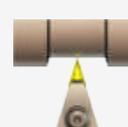

DVVN
Seite/page 17



PCLN
Seite/page 8



DVPN
Seite/page 13



Multitask Werkzeuge
Multitask tools
Outils multitâches
Seite/page 18-19



SDUC
Seite/page 8



SSBC
Seite/page 13



Aussengewinde
External thread
Filet extérieur
Seite/page 20



PDUN
Seite/page 8



PSBN
Seite/page 13



Innengewinde
Internal thread
Filet intérieur
Seite/page 21



SDJC
Seite/page 9



SSSC
Seite/page 14



PDJN
Seite/page 9



PSSN
Seite/page 14

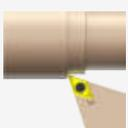

SDHC
Seite/page 9

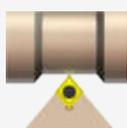

SCMC
Seite/page 15



PDHN
Seite/page 10



PCMN PWMN
Seite/page 15



SVUB SVUC
Seite/page 10

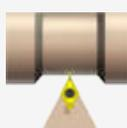

SDNC
Seite/page 16



DVUN
Seite/page 11



PDNN
Seite/page 16



Modulare Bohrstangen
Modular boring bars
Barres d'alésage modulables
 Seite/page 22



Bohrstangenhalter
Boring bar holder
Porte-outils d'alésage
 Seite/page 28+29



Verlängerung
Extension
Extension
 Seite/page 36



Schwingungs. Bohrstangen
Damped boring bar shanks
Damped barres d'alésage
 Seite/page 23



Wendeplattenbohrerhalter
Holder index. drill
Porte-outils à plaq index.
 Seite/page 29



Reduktion
Reduction
Reduction
 Seite/page 36



Wechselschneidköpfe
Exchangeable cutting heads
Têtes de coupe interchangeable.
 Seite/page 24+25



Abstechhalter radial
Cut-off block radial
Bloc de tronçonnage radial
 Seite/page 30



Trennstellenverschluss
Blanking plug
Bouchon d'ébauche
 Seite/page 36



SCLC
 Seite/page 26



Abstechhalter axial
Cut-off block axial
Bloc de tronçonnage axial
 Seite/page 31



Verlängerung
Extension
Extension
 Seite/page 37



PCLN
 Seite/page 26



Werkzeughalter radial
Tool holder radial
Porte-outil radial
 Seite/page 32



Schrumpffutter
Shrink chucks
Porte outils à frettage
 Seite/page 37



SDQC
 Seite/page 27



Werkzeughalter axial
Tool holder axial
Porte-outil axial
 Seite/page 33



Kühlmittelrohr
Coolant tube
tube d'arrosage
 Seite/page 37



PDQN
 Seite/page 27



Werkzeughalter axial 2-fach
Tool holder axial double
Porte-outil axial double
 Seite/page 34



Quick change Halter
Quick change holder
Porte-outils à quick change
 Seite/page 43+44



Werkzeughalter axial 3-fach
Tool holder axial triple
Porte-outil axial triple
 Seite/page 34



Ersatzteile
Spare parts
Pièces de rechange
 Seite/page 46



Werkzeughalter 45°
Tool holder 45°
Porte-outil 45°
 Seite/page 35

Bohrstangen mit Wechselschneidköpfen

- alle Wechselschneidköpfe sind mit Hochleistungskühlung ausgestattet.
- Werkzeugverschleiss tritt hauptsächlich am auswechselbaren Schneidkopf auf, der Adapter hält somit länger.
- In Kombination mit den SDT Bohrstangen ist das Konzept perfekt für Operationen mit langen Überhängen und bei Vibrationsneigung.

Boring bars with exchangeable cutting heads

- all exchangeable cutting heads are equipped with high performance coolant.
- Tool wear appears mainly at the changeable head, the life time of the tool adapter is therefore longer.
- In combination with SDT the tool concept is perfect for long cantilever extensions and while fighting with vibrations.

Barres d'alésage avec têtes de coupe interchangeables

- Toutes les têtes de coupe interchangeables sont équipées d'un arrosage haute performance.
- L'usure de l'outil apparaît principalement au niveau de la tête interchangeable, la durée de vie de l'adaptateur d'outil est donc plus longue.
- En combinaison avec SDT, le concept d'outil est parfait pour les longues extensions en porte-à-faux et tout en luttant contre les vibrations.



HP
inside

SWISS DAMPENING TECHNOLOGY

Schwingungsgedämpfte Bohrstangenschäfte

- Produktivitätsgewinn dank der unterdrückten Schwingungen können die Schnittdaten beträchtlich erhöht werden
- Verbesserte Oberflächengüte
- Verbesserte Prozesssicherheit
- Verbesserte Spanabfuhr
- Reduzierte Kosten pro Bauteil

Damped boring bar shanks

- Productivity improvement: thanks to reduced vibrations, the cutting conditions can be improved remarkable
- Better surface quality
- Improved process stability
- Better chip evacuation
- Reduced cost per part

Tiges de barres d'alésage anti-vibrations

- Amélioration de la productivité : grâce à la réduction des vibrations, les conditions de coupe peuvent être améliorées de façon remarquable.
- Meilleure qualité de surface
- Meilleure stabilité du processus
- Meilleure évacuation des copeaux
- Réduction du coût par pièce

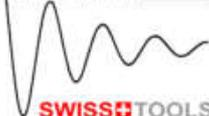

SDT 
SWISS DAMPENING TECHNOLOGY

SWISS TOOLS

Hochleistungskühlung

- für effiziente Drehbearbeitung
- optimale Kühlung durch fest ausgerichtete **High Pressure** Kühldüsen
- verbesserte Spankontrolle
- höhere Bearbeitungssicherheit
- mehr Zerspanvolumen
- kürzere Bearbeitungszeiten

High performance coolant

- to turn efficiently
- optimal cooling by fix orientated **High Pressure** coolant nozzles
- improved chip control
- higher manufacturing security
- higher chip removal rate
- shorter machining time

Arrosage haute performance

- pour des opérations de tournage efficaces
- arrosage optimal par des buses d'arrosage fixes High Pressure
- contrôle amélioré des copeaux
- plus grande sécurité d'usinage
- plus haut volume d'extraction de copeaux
- temps d'usinage plus courts

Klemmhalter

- alle Klemmhalter die mit dem **HP** Symbol markiert sind, können auf Hochleistungskühlung aufgerüstet werden.



Turning tool

- all turning tools which are marked with the **HP** symbol, can be set up with the high performance coolant.



Outil de tournage

- Tous les outils de tournage, qui sont marqués avec ce symbole **HP**, peuvent être équipés avec le arrosage haute performance.



Bestell-Nr. /
Order number/
Code

CHP.PCX.000.022

- Hochleistungskühlmittel Set beinhaltet:
 - HP Düse
 - O-Ring

- High performance coolant set included:
 - HP coolant nozzle
 - O-ring

- Kit d'arrosage haute performance comprend
 - Buse HP
 - O-Ring



- Spannsystem: Die Wendeplatte wird mittels Schraubenklemmung Typ S gespannt.
- Kühlsystem: Klemmhalter für positive Wendeplatten besitzen eine ausgerichtete Kühlmiteldüse.

- Clamping system: The insert is tightened via screw clamping Type S.
- Cooling system: Turning tools for positive inserts feature an adjusted coolant nozzle.

- Système de serrage : La plaquette est serrée par un serrage à vis de type S.
- Système d'arrosage : Les outils de tournage pour plaquettes positives sont équipés d'une buse d'arrosage dirigée.



- Spannsystem: Die Wendeplatte wird mittels Doppelklemmung Typ D gespannt.
- Kühlsystem: Klemmhalter mit Doppelklemmung verfügen über eine ausrichtbare Hochdruckkühl-düse.

- Clamping system: The insert is tightened via double-clamping Type D.
- Cooling system: Turning tools with double-clamping feature an adjustable high-pressure coolant nozzle.

- Système de serrage : La plaquette est serrée par un double serrage à vis de type D.
- Système d'arrosage : Les outils de tournage avec double serrage sont équipés d'une buse d'arrosage dirigée.



- Spannsystem: Die Wendeplatte wird mittels Kniehebelspannung Typ P gespannt.
- Kühlsystem: Klemmhalter mit Kniehebelspannung besitzen eine ausgerichtete Kühlmittel-düse.

- Clamping system: The insert is tightened via knuckle joint Type P.
- Cooling system: Turning tools with knuckle joint-clamping feature an adjusted coolant nozzle.

- Système de serrage : La plaquette est serrée par un joint articulé Type P.
- Système d'arrosage : Les outils de tournage avec joint articulé sont équipés d'une buse d'arrosage dirigée.

Klemhalter

- für effiziente Drehbearbeitung
- optimale Kühlung durch ausgerichtete Kühldüse und Hochdruckkühldüse
- Klemhalter für Aussenbearbeitung können auch für die Innenbearbeitung verwendet werden unter Berücksichtigung des D1 min.

Turning tool

- to turn efficiently
- optimal cooling by adjusted cooling nozzle and high pressure cooling nozzle
- Turning tools for exterior machining may also be used for interior machining, in consideration of D1 min.

Outil de tournage

- pour des opérations de tournage efficaces
- arrosage optimal par buse d'arrosage dirigée et à haute pression
- Les outils de tournage destinés à l'usinage extérieur peuvent aussi être utilisés pour l'usinage intérieur, en tenant compte de D1 min.

PWLN R/L 95°/80°

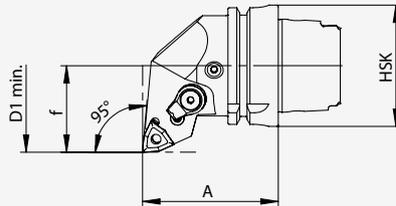

Bestell-Nr. / Order number / Code	HSK	f	D1 min.	A	Wendeplatte/ Insert/ Plaquette	kg					
HA4.PWD.(R/L)LA.055-HP	T40	27	50	55	WN ..06 04 ..	035	WWE.ER2.102.003	WDE-ER4.101.017 (3.0 Nm)	WDE-ER3.101.000	WDE-ER1.101.000	CHPPCX.000.022
HA4.PWE.(R/L)LA.055-HP	T40	27	50	55	WN ..08 04 ..	035	WWE.ER2.101.004	WCD-ER4.101.017 (5.0 Nm)	WDF-ER3.101.000	WCD-ER1.101.000	CHPPCX.000.022
HA6.PWE.(R/L)LA.070-HP	T63	45	80	70	WN ..08 04 ..	1.15	WWE.ER2.101.004	WCD-ER4.101.017 (5.0 Nm)	WDF-ER3.101.000	WCD-ER1.101.000	CHPPCX.000.022
HA6.PWE.(R/L)LA.100-HP	T63	45	80	100	WN ..08 04 ..	1.15	WWE.ER2.101.004	WCD-ER4.101.017 (5.0 Nm)	WDF-ER3.101.000	WCD-ER1.101.000	CHPPCX.000.022
HA0.PWE.(R/L)LA.100-HP	T100	63	120	100	WN ..08 04 ..	4.22	WWE.ER2.101.004	WCD-ER4.101.017 (5.0 Nm)	WDF-ER3.101.000	WCD-ER1.101.000	CHPPCX.000.022

SCLC R/L 95°/80°

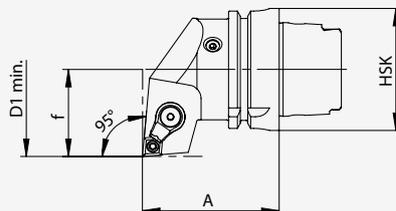

Bestell-Nr. / Order number / Code	HSK	f	D1 min.	A	Wendeplatte/ Insert/ Plaquette	kg			
HA4.KCB.(R/L)LA.055-HP	T40	27	50	55	CC ..09 T3 ..	0.40	WCB-ER1.001.000	WCB-ER2.001.009 (3.0 Nm)	CHPPCX.000.022
HA4.KCC.(R/L)LA.055-HP	T40	27	50	55	CC ..12 04 ..	0.40	WCC-ER1.001.000	WCC-ER2.001.010 (5.0 Nm)	CHPPCX.000.022
HA6.KCB.(R/L)LA.070-HP	T63	45	80	70	CC ..09 T3 ..	1.15	WCB-ER1.001.000	WCB-ER2.001.009 (3.0 Nm)	CHPPCX.000.022
HA6.KCC.(R/L)LA.070-HP	T63	45	80	70	CC ..12 04 ..	1.15	WCC-ER1.001.000	WCC-ER2.001.010 (5.0 Nm)	CHPPCX.000.022
HA0.KCC.(R/L)LA.100-HP	T100	63	120	100	CC ..12 04 ..	4.23	WCC-ER1.001.000	WCC-ER2.001.010 (5.0 Nm)	CHPPCX.000.022



Bestell-Nr. /
Order number /
Code

CHP.PCX.000.022

- Hochleistungskühlmittel Set beinhaltet:
- HP Düse
- O-Ring

- High performance coolant set included:
- HP coolant nozzle
- O-ring

- Kit d'arrosage haute performance comprend
- Buse HP
- O-Ring

PCLN R/L 95°/80°

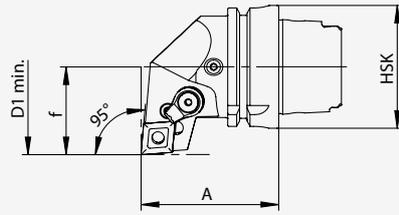

Bestell-Nr. / Order number/ Code	HSK	f	D1 min.	A	Wendeplatte/ Insert/ Plaquette	kg					
HA4.PCD.(R/L)LA.055-HP	T40	27	50	55	CN..12.04..	0.40	WCD.ER2.101.003	WCD.ER4.101.017 (5.0 Nm)	WCD.ER3.101.000	WCD.ER1.101.000	CHPPCX.000.022
HA6.PCD.(R/L)LA.070-HP	T63	45	80	70	CN..12.04..	1.15	WCD.ER2.101.003	WCD.ER4.101.017 (5.0 Nm)	WCD.ER3.101.000	WCD.ER1.101.000	CHPPCX.000.022
HA6.PCE.(R/L)LA.070-HP	T63	45	80	70	CN..16.06..	1.10	WCE.ER2.101.004	WCE.ER4.101.004 (5.0 Nm)	WCE.ER3.101.000	WCE.ER1.101.000	CHPPCX.000.022
HA0.PCD.(R/L)LA.100-HP	T100	63	120	100	CN..12.04..	4.40	WCD.ER2.101.003	WCD.ER4.101.017 (5.0 Nm)	WCD.ER3.101.000	WCD.ER1.101.000	CHPPCX.000.022
HA0.PCE.(R/L)LA.100-HP	T100	63	120	100	CN..16.06..	4.40	WCE.ER2.101.004	WCE.ER4.101.004 (5.0 Nm)	WCE.ER3.101.000	WCE.ER1.101.000	CHPPCX.000.022
HA0.PCF.(R/L)LA.100-HP	T100	63	120	100	CN..19.06..	4.40	WCF.ER2.101.000	WCF.ER4.101.027 (8.0 Nm)	WCF.ER3.101.000	WCF.ER1.101.000	CHPPCX.000.022

SDUC R/L 93°/55°

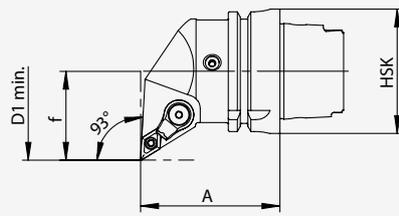

Bestell-Nr. / Order number/ Code	HSK	f	D1 min.	A	Wendeplatte/ Insert/ Plaquette	kg			
HA4.KDB.(R/L)UA.055-HP	T40	27	50	55	DC..11.T3..	0.35	WCB.ER1.001.000	WCB.ER2.001.009 (3.0 Nm)	CHPPCX.000.022
HA6.KDB.(R/L)UA.070-HP	T63	45	80	70	DC..11.T3..	1.20	WCB.ER1.001.000	WCB.ER2.001.009 (3.0 Nm)	CHPPCX.000.022
HA0.KDB.(R/L)UA.100-HP	T100	63	120	100	DC..11.T3..	4.10	WCB.ER1.001.000	WCB.ER2.001.009 (3.0 Nm)	CHPPCX.000.022

PDUN R/L 93°/55°

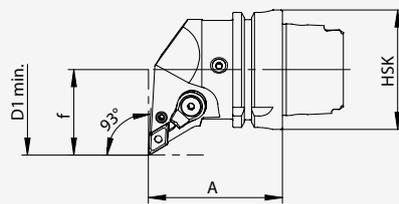

Bestell-Nr. / Order number/ Code	HSK	f	D1 min.	A	Wendeplatte/ Insert/ Plaquette	kg					
HA4.PDF.(R/L)UA.055-HP	T40	27	50	55	DN..15.06..*	0.35	WDF.ER2.101.003	WCD.ER4.101.017 (5.0 Nm)	WDF.ER3.101.000	WCD.ER1.101.000	CHPPCX.000.022
HA6.PDE.(R/L)UA.070-HP	T63	45	80	70	DN..11.04..	1.20	WDE.ER2.101.003	WDE.ER4.101.017 (3.0 Nm)	WDE.ER3.101.000		CHPPCX.000.022
HA6.PDF.(R/L)UA.070-HP	T63	45	80	70	DN..15.06..*	1.20	WDF.ER2.101.003	WCD.ER4.101.017 (5.0 Nm)	WDF.ER3.101.000	WCD.ER1.101.000	CHPPCX.000.022
HA0.PDF.(R/L)UA.100-HP	T100	63	120	100	DN..15.06..*	1.30	WDF.ER2.101.003	WCD.ER4.101.017 (5.0 Nm)	WDF.ER3.101.000	WCD.ER1.101.000	CHPPCX.000.022

* DN..15.04.. möglich mit Unterlegplatte WDF.ER2.101.004

* DN..15.04.. possible with tip pad WDF.ER2.101.004

* DN..15.04.. possible avec plateau de support WDF.ER2.101.004

SDJC R/L 55°/93°

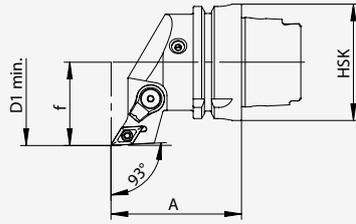

Bestell-Nr. / Order number/ Code	HSK	f	D1 min.	A	Wendeplatte/ Insert/ Plaquette	kg			
HA4.KDB.(R/L)JA.055-HP	T40	27	50	55	DC..11 T3..	0.35	WCB.ER1.001.000	WCB.ER2.001.009 (3.0 Nm)	CHPPCX.000.022
HA6.KDB.(R/L)JA.070-HP	T63	45	80	70	DC..11 T3..	1.00	WCB.ER1.001.000	WCB.ER2.001.009 (3.0 Nm)	CHPPCX.000.022
HA0.KDB.(R/L)JA.100	T100	63	120	100	DC..11 T3..	3.90	WCB.ER1.001.000	WCB.ER2.001.009 (3.0 Nm)	

PDJN R/L 55°/93°

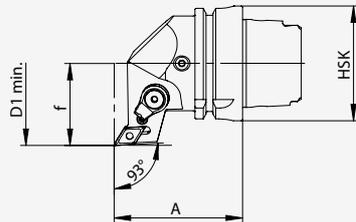

Bestell-Nr. / Order number/ Code	HSK	f	D1 min.	A	Wendeplatte/ Insert/ Plaquette	kg					
HA4.PDF.(R/L)JA.055-HP	T40	27	-	57	DN..15 06..*	0.35	WDF.ER2.101.003	WCD.ER4.101.017 (5.0 Nm)	WDF.ER3.101.000	WCD.ER1.101.000	CHPPCX.000.022
HA6.PDE.(R/L)JA.070-HP	T63	45	-	70	DN..11 04..	1.15	WDE.ER2.101.003	WDE.ER4.101.017 (3.0 Nm)	WDE.ER3.101.000		CHPPCX.000.022
HA6.PDF.(R/L)JA.070-HP	T63	45	-	70	DN..15 06..*	1.15	WDF.ER2.101.003	WCD.ER4.101.017 (5.0 Nm)	WDF.ER3.101.000	WCD.ER1.101.000	CHPPCX.000.022
HA0.PDF.(R/L)JA.100-HP	T100	63	-	100	DN..15 06..*	4.00	WDF.ER2.101.003	WCD.ER4.101.017 (5.0 Nm)	WDF.ER3.101.000	WCD.ER1.101.000	CHPPCX.000.022

* DN .. 15 04 .. möglich mit Unterlegplatte WDF.ER2.101.004

* DN .. 15 04 .. possible with tip pad WDF.ER2.101.004

* DN .. 15 04 .. possible avec plateau de support WDF.ER2.101.004

SDHC R/L 107.5°/55°

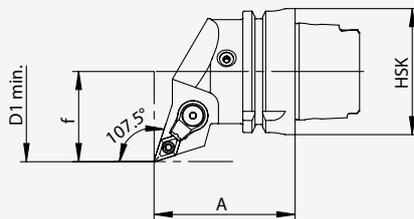

Bestell-Nr. / Order number/ Code	HSK	f	D1 min.	A	Wendeplatte/ Insert/ Plaquette	kg			
HA4.KDB.(R/L)HA.055-HP	T40	27	50	55	DC..11 T3..	0.35	WCB.ER1.001.000	WCB.ER2.001.009 (3.0 Nm)	CHPPCX.000.022
HA6.KDB.(R/L)HA.070-HP	T63	45	80	70	DC..11 T3..	1.00	WCB.ER1.001.000	WCB.ER2.001.009 (3.0 Nm)	CHPPCX.000.022
HA0.KDB.(R/L)HA.100	T100	63	120	100	DC..11 T3..	3.90	WCB.ER1.001.000	WCB.ER2.001.009 (3.0 Nm)	

PDHN R/L 107.5°/55°

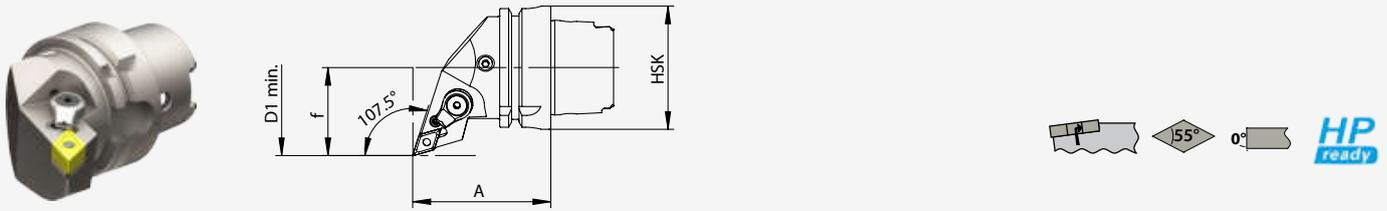

Bestell-Nr. / Order number/ Code	HSK	f	D1 min.	A	Wendeplatte/ Insert/ Plaquette	kg					
HA4.PDF.(R/L)HA.055-HP	T40	27	50	55	DN .. 15 06 ..*	0.35	WDF.ER2.101.003	WCD.ER4.101.017 (5.0 Nm)	WDF.ER3.101.000	WCD.ER1.101.000	CHPPCX.000.022
HA6.PDE.(R/L)HA.070-HP	T63	45	80	70	DN .. 11 04 ..	1.05	WDE.ER2.101.003	WDE.ER4.101.017 (3.0 Nm)	WDE.ER3.101.000		CHPPCX.000.022
HA6.PDF.(R/L)HA.070-HP	T63	45	80	70	DN .. 15 06 ..*	1.05	WDF.ER2.101.003	WCD.ER4.101.017 (5.0 Nm)	WDF.ER3.101.000	WCD.ER1.101.000	CHPPCX.000.022
HA0.PDF.(R/L)HA.100-HP	T100	63	120	100	DN .. 15 06 ..*	4.10	WDF.ER2.101.003	WCD.ER4.101.017 (5.0 Nm)	WDF.ER3.101.000	WCD.ER1.101.000	CHPPCX.000.022

* DN .. 15 04 .. möglich mit Unterlegplatte
WDF.ER2.101.004

* DN .. 15 04 .. possible with tip pad
WDF.ER2.101.004

* DN .. 15 04 .. possible avec plateau de
support WDF.ER2.101.004

SVUB R/L 93°/35°

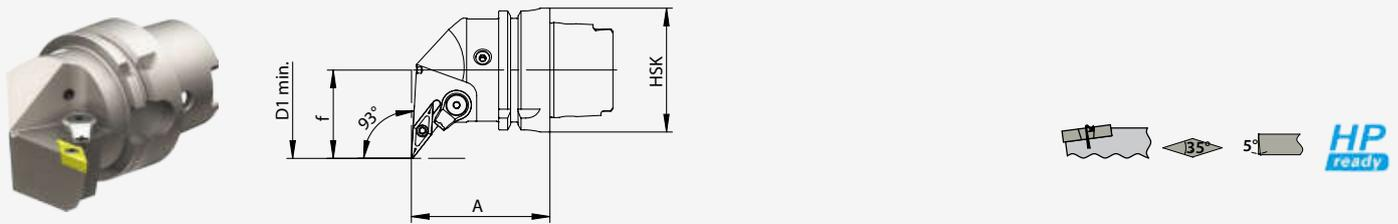

Bestell-Nr. / Order number/ Code	HSK	f	D1 min.	A	Wendeplatte/ Insert/ Plaquette	kg				
HA4.KVE.(R/L)UA.055	T40	27	50	55	VB .. 11 03 ..	0.35	WCA.ER1.001.000	WCA.ER2.001.006 (0.9 Nm)	WCB.ER1.001.000	WCB.ER2.001.009 (3.0 Nm)
HA4.KVF.(R/L)UA.055	T40	27	50	55	VB .. 16 04 ..	0.35	WCB.ER1.001.000	WCB.ER2.001.009 (3.0 Nm)	WCB.ER1.001.000	WCB.ER2.001.009 (3.0 Nm)
HA6.KVF.(R/L)UA.070-HP	T63	45	80	70	VB .. 16 04 ..	1.00	WCB.ER1.001.000	WCB.ER2.001.009 (3.0 Nm)	WCB.ER1.001.000	WCB.ER2.001.009 (3.0 Nm)
HA0.KVF.(R/L)UA.100	T100	63	120	100	VB .. 16 04 ..	4.10	WCB.ER1.001.000	WCB.ER2.001.009 (3.0 Nm)	WCB.ER1.001.000	WCB.ER2.001.009 (3.0 Nm)

SVUC R/L 93°/35°

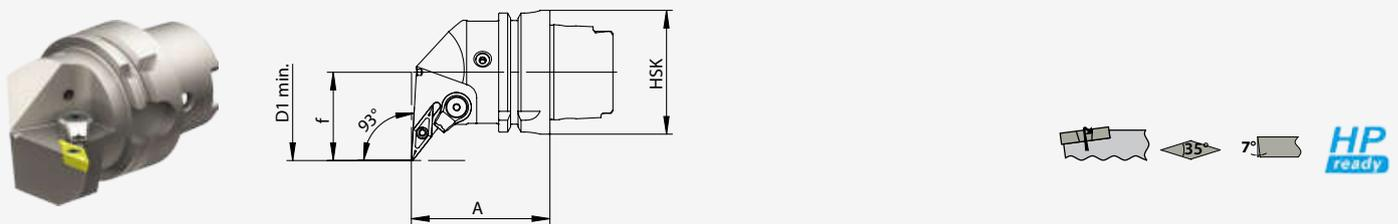

Bestell-Nr. / Order number/ Code	HSK	f	D1 min.	A	Wendeplatte/ Insert/ Plaquette	kg				
HA4.KVA.(R/L)UA.055-HP	T40	27	50	55	VC .. 11 03 ..	0.35	WCA.ER1.001.000	WCA.ER2.001.006 (0.9 Nm)	WCB.ER1.001.000	CHPPCX.000.022
HA4.KVB.(R/L)UA.055-HP	T40	27	50	55	VC .. 16 04 ..	0.35	WCB.ER1.001.000	WCB.ER2.001.009 (3.0 Nm)	WCB.ER1.001.000	WCB.ER2.001.009 (3.0 Nm)
HA6.KVB.(R/L)UA.070	T63	45	80	70	VC .. 16 04 ..	1.00	WCB.ER1.001.000	WCB.ER2.001.009 (3.0 Nm)	WCB.ER1.001.000	WCB.ER2.001.009 (3.0 Nm)
HA0.KVB.(R/L)UA.100	T100	63	120	100	VC .. 16 04 ..	4.10	WCB.ER1.001.000	WCB.ER2.001.009 (3.0 Nm)	WCB.ER1.001.000	WCB.ER2.001.009 (3.0 Nm)

DVUN R/L 93°/35°

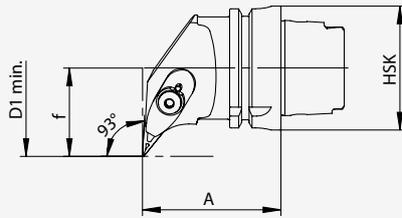

Bestell-Nr. / Order number/ Code	HSK	f	D1 min.	A	Wendeplatte/ Insert/ Plaquette	kg					
HA4.KVD.(R/L)UA.055	T40	27	-	55	VN..16 04..	0.35	WVD.ER2.101.003	WCB.ER2.001.009 (3.0 Nm)	WCC.ER4.103.032 (10 Nm)	WCC.ER5.102.012	WCC.ER3.102.024
HA6.KVD.(R/L)UA.070	T63	45	80	70	VN..16 04..	1.15	WVD.ER2.101.003	WCB.ER2.001.009 (3.0 Nm)	WCC.ER4.103.032 (10 Nm)	WCC.ER5.102.012	WCC.ER3.102.024
HA0.KVD.(R/L)UA.100	T100	63	120	100	VN..16 04..	4.20	WVD.ER2.101.003	WCB.ER2.001.009 (3.0 Nm)	WCC.ER4.103.032 (10 Nm)	WCC.ER5.102.012	WCC.ER3.102.024

SVJB R/L 35°/93°

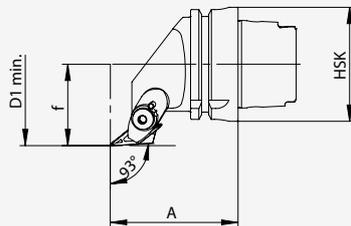

Bestell-Nr. / Order number/ Code	HSK	f	D1 min.	A	Wendeplatte/ Insert/ Plaquette	kg			
HA4.KVE.(R/L)JA.055	T40	27	50	55	VB..11 03..	0.40	WCA.ER1.001.000	WCA.ER2.001.006 (0.9 Nm)	WCB.ER2.001.009 (3.0 Nm)
HA4.KVF.(R/L)JA.060	T40	27	50	60	VB..16 04..	0.40	WCB.ER1.001.000	WCB.ER2.001.009 (3.0 Nm)	WCB.ER2.001.009 (3.0 Nm)
HA6.KVF.(R/L)JA.070	T63	45	80	71.5	VB..16 04..	1.00	WCB.ER1.001.000	WCB.ER2.001.009 (3.0 Nm)	WCB.ER2.001.009 (3.0 Nm)
HA0.KVF.(R/L)JA.100	T100	63	120	100	VB..16 04..	3.70	WCB.ER1.001.000	WCB.ER2.001.009 (3.0 Nm)	WCB.ER2.001.009 (3.0 Nm)

SVJC R/L 35°/93°

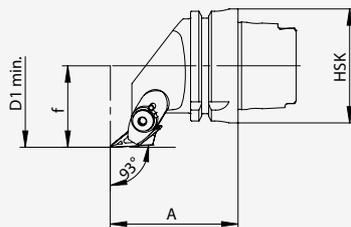

Bestell-Nr. / Order number/ Code	HSK	f	D1 min.	A	Wendeplatte/ Insert/ Plaquette	kg			
HA4.KVA.(R/L)JA.055	T40	27	50	55	VC..11 03..	0.40	WCA.ER1.001.000	WCA.ER2.001.006 (0.9 Nm)	WCB.ER2.001.009 (3.0 Nm)
HA4.KVB.(R/L)JA.060	T40	27	50	60	VC..16 04..	0.40	WCB.ER1.001.000	WCB.ER2.001.009 (3.0 Nm)	WCB.ER2.001.009 (3.0 Nm)
HA6.KVB.(R/L)JA.070	T63	45	80	71.5	VC..16 04..	1.00	WCB.ER1.001.000	WCB.ER2.001.009 (3.0 Nm)	WCB.ER2.001.009 (3.0 Nm)
HA0.KVB.(R/L)JA.100	T100	63	120	100	VC..16 04..	3.70	WCB.ER1.001.000	WCB.ER2.001.009 (3.0 Nm)	WCB.ER2.001.009 (3.0 Nm)

DVJN R/L 35°/93°

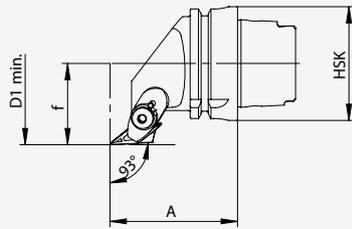

Bestell-Nr. / Order number/ Code	HSK	f	D1 min.	A	Wendeplatte/ Insert/ Plaquette	kg					
HA6.KVD.(R/L)JA.070	T63	45	-	70	VN...16 04...	1.00	WVD.ER2.101.003	WCB.ER2.001.009 (3.0 Nm)	WCC.ER4.103.032 (10 Nm)	WCC.ER5.102.012	WCC.ER3.102.024
HA0.KVD.(R/L)JA.100	T100	63	-	100	VN...16 04...	3.80	WVD.ER2.101.003	WCB.ER2.001.009 (3.0 Nm)	WCC.ER4.103.032 (10 Nm)	WCC.ER5.102.012	WCC.ER3.102.024

SVPB R/L 117.5°/35°

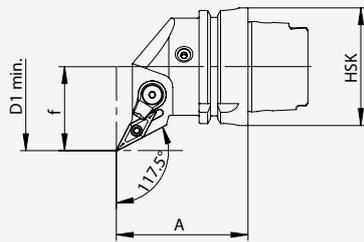

Bestell-Nr. / Order number/ Code	HSK	f	D1 min.	A	Wendeplatte/ Insert/ Plaquette	kg			
HA4.KVF.(R/L)PA.055-HP	T40	27	50	55	VB...16 04...	0.40	WCB.ER1.001.000	WCB.ER2.001.009 (3.0 Nm)	CHPPCX.000.022
HA6.KVF.(R/L)PA.070-HP	T63	45	80	70	VB...16 04...	1.00	WCB.ER1.001.000	WCB.ER2.001.009 (3.0 Nm)	
HA0.KVF.(R/L)PA.100-HP	T100	63	120	100	VB...16 04...	4.00	WCB.ER1.001.000	WCB.ER2.001.009 (3.0 Nm)	

SVPC R/L 117.5°/35°

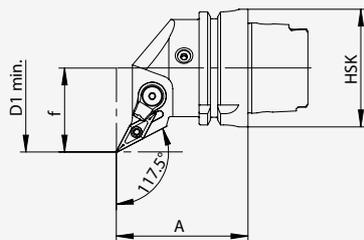

Bestell-Nr. / Order number/ Code	HSK	f	D1 min.	A	Wendeplatte/ Insert/ Plaquette	kg			
HA4.KVA.(R/L)PA.055	T40	27	50	55	VC...11 03...	0.40	WCA.ER1.001.000	WCA.ER2.001.006 (0.9 Nm)	
HA4.KVB.(R/L)PA.055	T40	27	50	55	VC...16 04...	0.40	WCB.ER1.001.000	WCB.ER2.001.009 (3.0 Nm)	
HA6.KVB.(R/L)PA.070-HP	T63	45	80	70	VC...16 04...	1.00	WCB.ER1.001.000	WCB.ER2.001.009 (3.0 Nm)	CHPPCX.000.022
HA0.KVB.(R/L)PA.100-HP	T100	63	120	100	VC...16 04...	4.00	WCB.ER1.001.000	WCB.ER2.001.009 (3.0 Nm)	

DVPN R/L 117.5°/35°

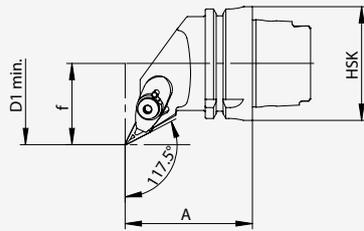

Bestell-Nr. / Order number / Code	HSK	f	D1 min.	A	Wendeplatte/ Insert/ Plaquette	kg					
HA4.KVD.(R/L)PA.055-HP	T40	27	-	55	VN...16 04..	0.40	WVD.ER2.101.003	WCB.ER2.001.009 (3.0 Nm)	WCC.ER4.103.032 (10 Nm)	WCC.ER5.102.012	WCC.ER3.102.024
HA6.KVD.(R/L)PA.070	T63	45	80	70	VN...16 04..	1.00	WVD.ER2.101.003	WCB.ER2.001.009 (3.0 Nm)	WCC.ER4.103.032 (10 Nm)	WCC.ER5.102.012	WCC.ER3.102.024
HA0.KVD.(R/L)PA.100	T100	63	120	100	VN...16 04..	4.00	WVD.ER2.101.003	WCB.ER2.001.009 (3.0 Nm)	WCC.ER4.103.032 (10 Nm)	WCC.ER5.102.012	WCC.ER3.102.024

SSBC R/L 90°/75°

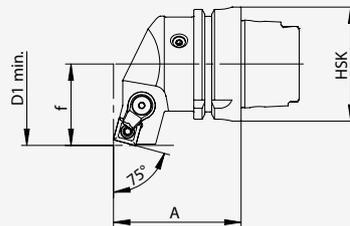

Bestell-Nr. / Order number / Code	HSK	f	D1 min.	A	Wendeplatte/ Insert/ Plaquette	kg			
HA4.KSB.(R/L)BA.055-HP	T40	27	-	55	SC...12 04..	0.35	WCC.ER1.001.000	WCC.ER2.001.010 (5.0 Nm)	WCB.ER2.001.009 (3.0 Nm)
HA6.KSB.(R/L)BA.070	T63	45	-	70	SC...12 04..	1.00	WCB.ER1.001.000	WCB.ER2.001.009 (3.0 Nm)	
HA0.KSB.(R/L)BA.100	T100	63	-	100	SC...12 04..	4.15	WCC.ER1.001.000	WCC.ER2.001.010 (5.0 Nm)	

PSBN R/L 90°/75°

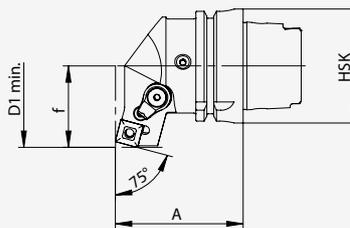

Bestell-Nr. / Order number / Code	HSK	f	D1 min.	A	Wendeplatte/ Insert/ Plaquette	kg				
HA4.PSD.(R/L)BA.055	T40	27	-	55	SN...12 04..	0.35	WSD.ER2.101.003	WCD.ER4.101.017 (5.0 Nm)	WCD.ER3.101.000	WCD.ER1.101.000
HA6.PSD.(R/L)BA.070	T63	45	-	70	SN...12 04..	1.00	WSD.ER2.101.003	WCD.ER4.101.017 (5.0 Nm)	WCD.ER3.101.000	WCD.ER1.101.000
HA0.PSD.(R/L)BA.100-HP	T100	63	-	100	SN...12 04..	4.15	WSD.ER2.101.003	WCD.ER4.101.017 (5.0 Nm)	WCD.ER3.101.000	WCD.ER1.101.000

SSSC R/L 90°/45°

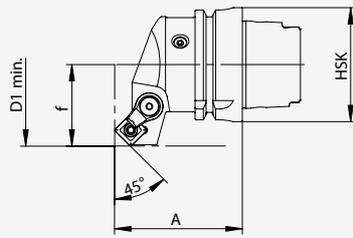

Bestell-Nr. / Order number/ Code	HSK	f	D1 min.	A	Wendeplatte/ Insert/ Plaquette	kg			
HA4.KSB.(R/L)SA.055	T40	27	-	55	SC...12 04 ..	0.40	WCC.ER1.001.000	WCC.ER2.001.010 (5.0 Nm)	
HA6.KSB.(R/L)SA.070	T63	45	-	70	SC...12 04 ..	1.00	WCB.ER1.001.000	WCB.ER2.001.009 (3.0 Nm)	
HA0.KSB.(R/L)SA.100	T100	63	-	100	SC...12 04 ..	4.00	WCC.ER1.001.000	WCC.ER2.001.010 (5.0 Nm)	

PSSN R/L 90°/45°

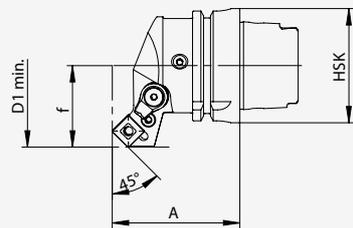

Bestell-Nr. / Order number/ Code	HSK	f	D1 min.	A	Wendeplatte/ Insert/ Plaquette	kg				
HA4.PSD.(R/L)SA.055	T40	27	-	55	SN...12 04 ..	0.40	WSD.ER2.101.003	WCD.ER4.101.017 (5.0 Nm)	WCD.ER3.101.000	WCD.ER1.101.000
HA6.PSD.(R/L)SA.070-HP	T63	45	-	70	SN...12 04 ..	1.00	WSD.ER2.101.003	WCD.ER4.101.017 (5.0 Nm)	WCD.ER3.101.000	WCD.ER1.101.000
HA0.PSD.(R/L)SA.100-HP	T100	63	-	100	SN...12 04 ..	4.00	WSD.ER2.101.003	WCD.ER4.101.017 (5.0 Nm)	WCD.ER3.101.000	WCD.ER1.101.000

SCMC N 50°/80°/50°

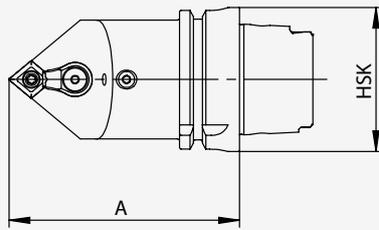

Bestell-Nr. / Order number/ Code	HSK	A	Wendeplatte/ Insert/ Plaquette	kg			
HA4.KCB.NMA.080-HP	T40	80	CC...09 T3 ..	0.46	WCB.ER1.001.000	WCB.ER2.001.009 (3.0 Nm)	CHPPCX.000.022
HA4.KCC.NMA.080-HP	T40	80	CC...12 04 ..	0.46	WCC.ER1.001.000	WCC.ER2.001.010 (5.0 Nm)	CHPPCX.000.022
HA6.KCC.NMA.100-HP	T63	100	CC...12 04 ..	1.35	WCC.ER1.001.000	WCC.ER2.001.010 (5.0 Nm)	CHPPCX.000.022
HA6.KCC.NMA.130-HP	T63	130	CC...12 04 ..	1.84	WCC.ER1.001.000	WCC.ER2.001.010 (5.0 Nm)	CHPPCX.000.022
HA0.KCC.NMA.125-HP	T100	125	CC...12 04 ..	4.60	WCC.ER1.001.000	WCC.ER2.001.010 (5.0 Nm)	CHPPCX.000.022

PCMN N 50°/80°/50°

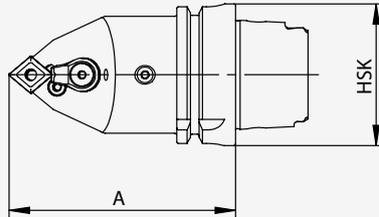

Bestell-Nr. / Order number/ Code	HSK	A	Wendeplatte/ Insert/ Plaquette	kg					
HA4.PCD.NMA.080	T40	80	CN...12 04 ..	0.46	WCD.ER2.101.003	WCD.ER4.101.017 (5.0 Nm)	WCD.ER3.101.000	WCD.ER1.101.000	
HA6.PCD.NMA.100-HP	T63	100	CN...12 04 ..	1.35	WCD.ER2.101.003	WCD.ER4.101.017 (5.0 Nm)	WCD.ER3.101.000	WCD.ER1.101.000	CHPPCX.000.022
HA6.PCD.NMA.130-HP	T63	130	CN...12 04 ..	1.84	WCD.ER2.101.003	WCD.ER4.101.017 (5.0 Nm)	WCD.ER3.101.000	WCD.ER1.101.000	CHPPCX.000.022
HA6.PCE.NMA.100-HP	T63	100	CN...16 06 ..	1.35	WCE.ER2.101.004	WCE.ER4.101.004 (5.0 Nm)	WCE.ER3.101.000	WCE.ER1.101.000	CHPPCX.000.022
HA6.PCE.NMA.130-HP	T63	130	CN...16 06 ..	1.84	WCE.ER2.101.004	WCE.ER4.101.004 (5.0 Nm)	WCE.ER3.101.000	WCE.ER1.101.000	CHPPCX.000.022
HA0.PCD.NMA.125-HP	T100	125	CN...12 04 ..	4.60	WCD.ER2.101.003	WCD.ER4.101.017 (5.0 Nm)	WCD.ER3.101.000	WCD.ER1.101.000	CHPPCX.000.022
HA0.PCE.NMA.125-HP	T100	125	CN...16 06 ..	4.60	WCE.ER2.101.004	WCE.ER4.101.004 (5.0 Nm)	WCE.ER3.101.000	WCE.ER1.101.000	CHPPCX.000.022

PWMC N 50°/80°/50°

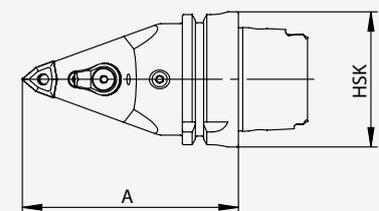

Bestell-Nr. / Order number/ Code	HSK	A	Wendeplatte/ Insert/ Plaquette	kg					
HA6.PWE.NMA.100-HP	T63	100	WN...08 04 ..	1.40	WWE.ER2.101.004	WCD.ER4.101.017 (5.0 Nm)	WDF.ER3.101.000	WCD.ER1.101.000	CHPPCX.000.022
HA6.PWE.NMA.130-HP	T63	130	WN...08 04 ..	1.80	WWE.ER2.101.004	WCD.ER4.101.017 (5.0 Nm)	WDF.ER3.101.000	WCD.ER1.101.000	CHPPCX.000.022

SDNC N 62.5°/55°/62.5°

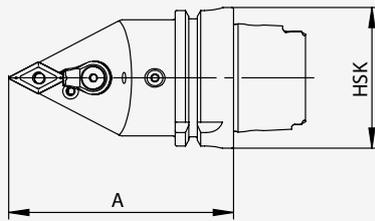

Bestell-Nr. / Order number/ Code	HSK	A	Wendeplatte/ Insert/ Plaquette	kg			
HA4.KDB.NNA.080-HP	T40	80	DC...11 T3...	0.40	WCB.ER1.001.000	WCB.ER2.001.009 (3.0 Nm)	CHPPCX.000.022
HA6.KDB.NNA.100-HP	T63	100	DC...11 T3...	1.40	WCB.ER1.001.000	WCB.ER2.001.009 (3.0 Nm)	CHPPCX.000.022
HA6.KDB.NNA.130-HP	T63	130	DC...11 T3...	1.80	WCB.ER1.001.000	WCB.ER2.001.009 (3.0 Nm)	CHPPCX.000.022
HA0.KDB.NNA.125-HP	T100	125	DC...11 T3...	4.30	WCB.ER1.001.000	WCB.ER2.001.009 (3.0 Nm)	CHPPCX.000.022

PDNN N 62.5°/55°/62.5°

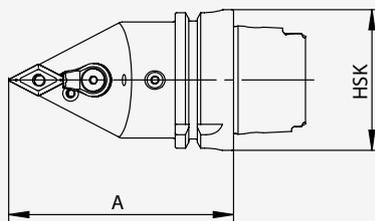

Bestell-Nr. / Order number/ Code	HSK	A	Wendeplatte/ Insert/ Plaquette	kg					
HA4.PDF.NNA.080-HP	T40	80	DN...15 06...*	0.40	WDF.ER2.101.003	WCC.ER4.103.032 (10 Nm)	WCC.ER5.102.012	WCC.ER3.102.024	CHPPCX.000.022
HA6.PDF.NNA.100-HP	T63	100	DN...15 06...*	1.40	WDF.ER2.101.003	WCC.ER4.103.032 (10 Nm)	WCC.ER5.102.012	WCC.ER3.102.024	CHPPCX.000.022
HA6.PDF.NNA.130-HP	T63	130	DN...15 06...*	1.80	WDF.ER2.101.003	WCC.ER4.103.032 (10 Nm)	WCC.ER5.102.012	WCC.ER3.102.024	CHPPCX.000.022
HA0.PDF.NNA.125-HP	T100	125	DN...15 06...*	4.30	WDF.ER2.101.003	WCC.ER4.103.032 (10 Nm)	WCC.ER5.102.012	WCC.ER3.102.024	CHPPCX.000.022

* DN...15 04... möglich mit Unterlegplatte
WDF.ER2.101.004

* DN...15 04... possible with tip pad
WDF.ER2.101.004

* DN...15 04... possible avec plateau de
support WDF.ER2.101.004

SVVB N 72.5°/35°/72.5°

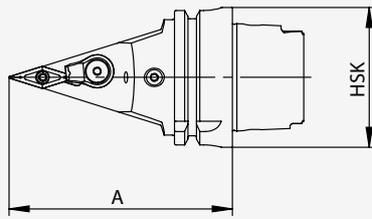

Bestell-Nr. / Order number/ Code	HSK	A	Wendeplatte/ Insert/ Plaquette	kg			
HA4.KVF.NVA.080-HP	T40	80	VB .. 16 04 ..	0.45	WCB.ER1.001.000	WCB.ER2.001.009 (3.0 Nm)	
HA6.KVF.NVA.100-HP	T63	100	VB .. 16 04 ..	1.62	WCB.ER1.001.000	WCB.ER2.001.009 (3.0 Nm)	
HA6.KVE.NVA.130-HP	T63	130	VB .. 11 03 ..	1.52	WCA.ER1.001.000	WCA.ER2.001.006 (0.9 Nm)	CHPPCX.000.022
HA6.KVF.NVA.130-HP	T63	130	VB .. 16 04 ..	1.52	WCB.ER1.001.000	WCB.ER2.001.009 (3.0 Nm)	CHPPCX.000.022
HA0.KVF.NVA.125-HP	T100	125	VB .. 16 04 ..	4.00	WCB.ER1.001.000	WCB.ER2.001.009 (3.0 Nm)	CHPPCX.000.022

SVVC N 72.5°/35°/72.5°

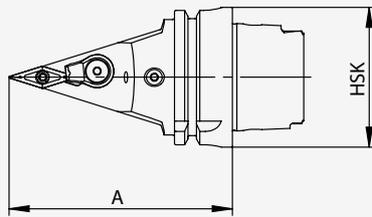

Bestell-Nr. / Order number/ Code	HSK	A	Wendeplatte/ Insert/ Plaquette	kg			
HA4.KVA.NVA.055	T40	55	VC .. 11 03 ..	0.40	WCA.ER1.001.000	WCA.ER2.001.006 (0.9 Nm)	CHPPCX.000.022
HA4.KVB.NVA.080-HP	T40	80	VC .. 16 04 ..	0.45	WCB.ER1.001.000	WCB.ER2.001.009 (3.0 Nm)	CHPPCX.000.022
HA6.KVA.NVA.100-HP	T63	100	VC .. 11 03 ..	1.24	WCA.ER1.001.000	WCA.ER2.001.006 (0.9 Nm)	CHPPCX.000.022
HA6.KVB.NVA.100-HP	T63	100	VC .. 16 04 ..	1.24	WCB.ER1.001.000	WCB.ER2.001.009 (3.0 Nm)	CHPPCX.000.022
HA6.KVB.NVA.130-HP	T63	130	VC .. 16 04 ..	1.85	WCB.ER1.001.000	WCB.ER2.001.009 (3.0 Nm)	CHPPCX.000.022
HA0.KVB.NVA.125-HP	T100	125	VC .. 16 04 ..	4.00	WCB.ER1.001.000	WCB.ER2.001.009 (3.0 Nm)	CHPPCX.000.022

DVVN N 72.5°/35°/72.5°

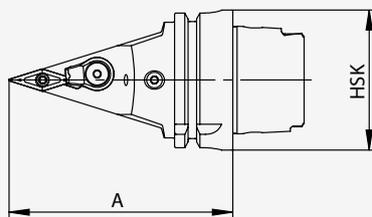

Bestell-Nr. / Order number/ Code	HSK	A	Wendeplatte/ Insert/ Plaquette	kg					
HA4.KVD.NVA.080	T40	80	VN .. 16 04 ..	0.45	WVD.ER2.101.003	WCB.ER2.001.009 (3.0 Nm)	WCC.ER5.102.012	WCC.ER3.102.029	WCC.ER3.102.024
HA6.KVD.NVA.100	T63	100	VN .. 16 04 ..	2.22	WVD.ER2.101.003	WCB.ER2.001.009 (3.0 Nm)	WCC.ER5.102.012	WCC.ER3.102.029	WCC.ER3.102.024
HA6.KVD.NVA.130	T63	130	VN .. 16 04 ..	1.50	WVD.ER2.101.003	WCB.ER2.001.009 (3.0 Nm)	WCC.ER5.102.012	WCC.ER3.102.029	WCC.ER3.102.024
HA0.KVD.NVA.125	T100	125	VN .. 16 04 ..	4.00	WVD.ER2.101.003	WCB.ER2.001.009 (3.0 Nm)	WCC.ER5.102.012	WCC.ER3.102.029	WCC.ER3.102.024
HA0.KVD.NVA.180	T100	180	VN .. 16 04 ..	6.10	WVD.ER2.101.003	WCB.ER2.001.009 (3.0 Nm)	WCC.ER5.102.012	WCC.ER3.102.029	WCC.ER3.102.024

PDMN L 48° (93°)/55°

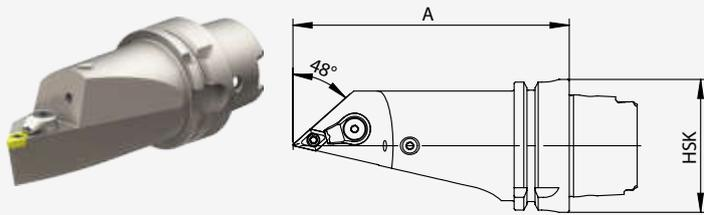

Bestell-Nr. / Order number/ Code	HSK	A	Wendeplatte/ Insert/ Plaquette	kg					
HA6.KDB.NXA.130	T63	130	DC . . 11 T3 . .	1.56	WCB.ER1.001.000	WCB.ER2.001.009 (3.0 Nm)	CHPPCX.000.022	WCD.ER1.101.000	CHPPCX.000.022
HA6.KDB.NXA.150	T63	150	DN . . 15 06 . . *	1.75	WDF.ER2.101.003	WCD.ER4.101.017 (5.0 Nm)	WDF.ER3.101.000	WCD.ER1.101.000	CHPPCX.000.022
HA6.PDF.NXA.130-HP	T63	130	DN . . 15 06 . . *	1.56	WDF.ER2.101.003	WCD.ER4.101.017 (5.0 Nm)	WDF.ER3.101.000	WCD.ER1.101.000	CHPPCX.000.022
HA0.PDF.NXA.125-HP	T100	125	DN . . 15 06 . . *	4.30	WDF.ER2.101.003	WCD.ER4.101.017 (5.0 Nm)	WDF.ER3.101.000	WCD.ER1.101.000	CHPPCX.000.022

* DN . . 15 04 . . möglich mit Unterlegplatte
WDF.ER2.101.004

* DN . . 15 04 . . possible with tip pad
WDF.ER2.101.004

* DN . . 15 04 . . possible avec plateau de
support WDF.ER2.101.004

SVMB L 50° (95°)/35°

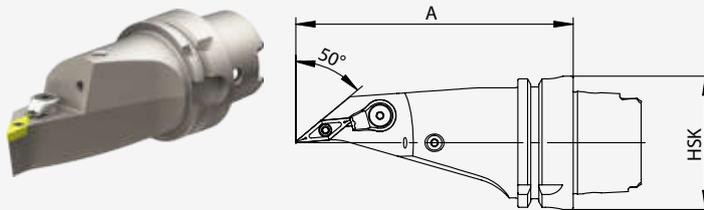

Bestell-Nr. / Order number/ Code	HSK	A	Wendeplatte/ Insert/ Plaquette	kg			
HA6.KVF.NMA.130-HP	T63	130	VB . . 16 04 . .	1.46	WCB.ER1.001.000	WCB.ER2.001.009 (3.0 Nm)	CHPPCX.000.022
HA0.KVF.NMA.125	T100	125	VB . . 16 04 . .	3.77	WCB.ER1.001.000	WCB.ER2.001.009 (3.0 Nm)	CHPPCX.000.022

SVMC L 50° (95°)/35°

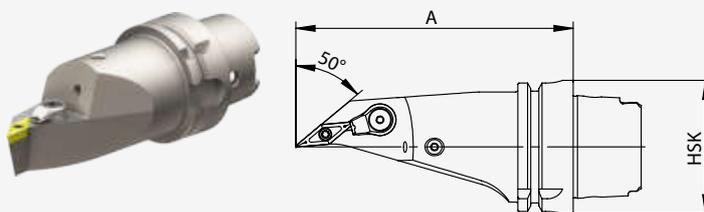

Bestell-Nr. / Order number/ Code	HSK	A	Wendeplatte/ Insert/ Plaquette	kg			
HA6.KVB.NMA.130-HP	T63	130	VC . . 16 04 . .	1.46	WCB.ER1.001.000	WCB.ER2.001.009 (3.0 Nm)	CHPPCX.000.022

DVMN L 50° (95°)/35°

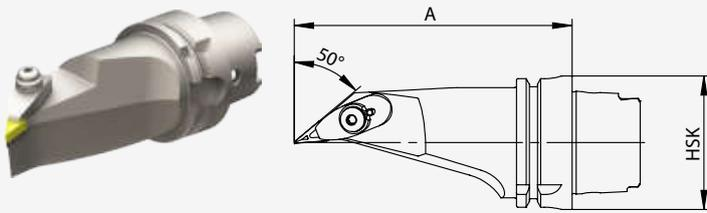

Bestell-Nr. / Order number/ Code	HSK	A	Wendeplatte/ Insert/ Plaquette	kg					
HA6.KVD.NMA.130	T63	130	VN .. 16 04 ..	1.48	WDF.ER2.101.003	WCB.ER2.001.009 (3.0 Nm)	WCC.ER5.102.012	WCC.ER3.102.029	WCC.ER3.102.024

T DCM 50° (95°) / DDM 48° (93°)

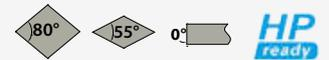
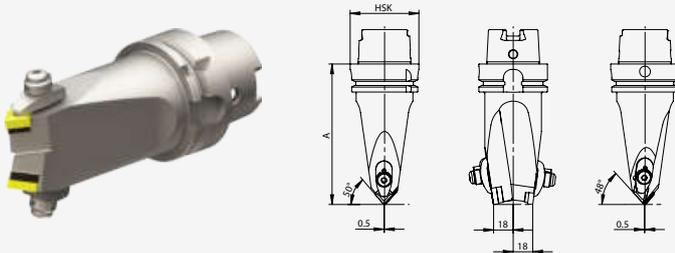

Bestell-Nr. / Order number/ Code	HSK	A	Wendeplatte/ Insert/ Plaquette	kg					
HA6.KCD.NXD.130	T63	130	DN .. 15 06 .. * CN .. 12 04 ..	1.75	WDF.ER2.101.003 WCD.ER2.101.003	WCC.ER4.103.032 (10 Nm)	WCC.ER5.102.012	WCC.ER3.102.029	WCC.ER3.102.024 WCC.ER3.102.024

* DN .. 15 04 .. möglich mit Unterlegplatte
WDF.ER2.101.004

* DN .. 15 04 .. possible with tip pad
WDF.ER2.101.004

* DN .. 15 04 .. possible avec plateau de
support WDF.ER2.101.004

Aussengewinde radial

External thread radial

Filet extérieur radial

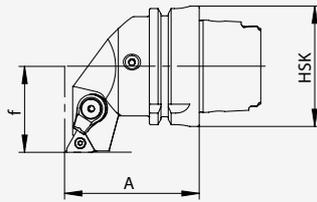

Bestell-Nr. / Order number/ Code	HSK	f	D1 min.	A	R/L	Wendeplatte/ Insert/ Plaquette	kg				
HA4.KGB.RGR.055	T40	27	-	55	R	16 ER	0.34	WGB.ER1.001.000	WGB.ER2.001.012 (2.0 Nm)	WGB.ER2.102.003	WGB.ER3.001.007 (2.0 Nm)
HA4.KGB.LGR.055	T40	27	-	55	L	16 EL	0.34	WGB.ER1.001.000	WGB.ER2.001.012 (2.0 Nm)	WGB.ER2.101.003	WGB.ER3.001.007 (2.0 Nm)
HA6.KGB.RGR.070	T63	45	-	70	R	16 ER	1.08	WGB.ER1.001.000	WGB.ER2.001.012 (2.0 Nm)	WGB.ER2.102.003	WGB.ER3.001.007 (2.0 Nm)
HA6.KGB.LGR.070	T63	45	-	70	L	16 EL	1.08	WGB.ER1.001.000	WGB.ER2.001.012 (2.0 Nm)	WGB.ER2.101.003	WGB.ER3.001.007 (2.0 Nm)
HA0.KGB.RGR.100	T100	63	-	100	R	16 ER	4.29	WGB.ER1.001.000	WGB.ER2.001.012 (2.0 Nm)	WGB.ER2.102.003	WGB.ER3.001.007 (2.0 Nm)
HA0.KGB.LGR.100	T100	63	-	100	L	16 EL	4.29	WGB.ER1.001.000	WGB.ER2.001.012 (2.0 Nm)	WGB.ER2.101.003	WGB.ER3.001.007 (2.0 Nm)
HA0.KGC.RGR.100	T100	63	-	100	R	22 ER	4.29	WGC.ER1.001.000	WGC.ER2.001.015 (3.0 Nm)	WGC.ER2.102.004	WGC.ER3.001.009 (2.0 Nm)
HA0.KGC.LGR.100	T100	63	-	100	L	22 EL	4.29	WGC.ER1.001.000	WGC.ER2.001.015 (3.0 Nm)	WGC.ER2.102.004	WGC.ER3.001.009 (2.0 Nm)

Aussengewinde axial

External thread axial

Filet extérieur axial

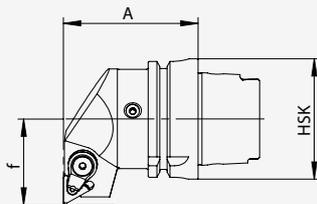

Bestell-Nr. / Order number/ Code	HSK	f	D1 min.	A	R/L	Wendeplatte/ Insert/ Plaquette	kg				
HA4.KGB.RGA.055	T40	27	-	55	R	16 EL	0.36	WGB.ER1.001.000	WGB.ER2.001.012 (2.0 Nm)	WGB.ER2.102.003	WGB.ER3.001.007 (2.0 Nm)
HA4.KGB.LGA.055	T40	27	-	55	L	16 ER	0.36	WGB.ER1.001.000	WGB.ER2.001.012 (2.0 Nm)	WGB.ER2.101.003	WGB.ER3.001.007 (2.0 Nm)
HA6.KGB.RGA.070	T63	45	-	70	R	16 EL	1.14	WGB.ER1.001.000	WGB.ER2.001.012 (2.0 Nm)	WGB.ER2.102.003	WGB.ER3.001.007 (2.0 Nm)
HA6.KGB.LGA.070	T63	45	-	70	L	16 ER	1.14	WGB.ER1.001.000	WGB.ER2.001.012 (2.0 Nm)	WGB.ER2.101.003	WGB.ER3.001.007 (2.0 Nm)
HA0.KGB.RGA.100	T100	63	-	100	R	16 EL	4.46	WGB.ER1.001.000	WGB.ER2.001.012 (2.0 Nm)	WGB.ER2.102.003	WGB.ER3.001.007 (2.0 Nm)
HA0.KGB.LGA.100	T100	63	-	100	L	16 ER	4.46	WGB.ER1.001.000	WGB.ER2.001.012 (2.0 Nm)	WGB.ER2.101.003	WGB.ER3.001.007 (2.0 Nm)

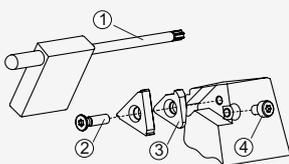

Für Gewindehalter For thread tool	Typ/ Type	Bestell-Nr. / Order number	Bestell-Nr. / Order number	Bestell-Nr. / Order number	Bestell-Nr. / Order number
		Torx-Schlüssel/ Torx driver	Torx-Schraube Torx screw	Zwischenlage/ Tip pad	Schraube/ Screw
xxx.KGB.RGR.xxx	G01	WGB.ER1.001.000	WGB.ER2.001.012 (2.0 Nm)	WGB.ER2.102.003	WGB.ER3.001.007 (2.0 Nm)
xxx.KGB.LGR.xxx	G02	WGB.ER1.001.000	WGB.ER2.001.012 (2.0 Nm)	WGB.ER2.101.003	WGB.ER3.001.007 (2.0 Nm)
xxx.xGB.RGA.xxx	G03	WGB.ER1.001.000	WGB.ER2.001.012 (2.0 Nm)	WGB.ER2.101.003	WGB.ER3.001.007 (2.0 Nm)
xxx.xGB.LGA.xxx	G04	WGB.ER1.001.000	WGB.ER2.001.012 (2.0 Nm)	WGB.ER2.102.003	WGB.ER3.001.007 (2.0 Nm)

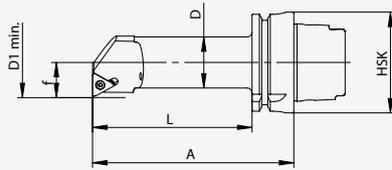

Bestell-Nr. / Order number/ Code	HSK	f	D	D1 min.	A	L	Wendeplatte/ Insert/ Plaquette	kg				
HA4.BGB.RGA.110	T40	17	25	32	110	90	16 IR	0.49	WGB.ER1.001.000	WGB.ER2.001.012 (2.0 Nm)	WGB.ER2.102.003	WGB.ER3.001.007 (2.0 Nm)
HA4.BGB.LGA.110	T40	17	25	32	110	90	16 IL	0.49	WGB.ER1.001.000	WGB.ER2.001.012 (2.0 Nm)	WGB.ER2.101.003	WGB.ER3.001.007 (2.0 Nm)
HA6.BGB.RGA.125	T63	22	32	40	125	99	16 IR	1.17	WGB.ER1.001.000	WGB.ER2.001.012 (2.0 Nm)	WGB.ER2.102.003	WGB.ER3.001.007 (2.0 Nm)
HA6.BGB.LGA.125	T63	22	32	40	125	99	16 IL	1.17	WGB.ER1.001.000	WGB.ER2.001.012 (2.0 Nm)	WGB.ER2.101.003	WGB.ER3.001.007 (2.0 Nm)
HA6.BGB.RGA.140	T63	27	40	50	140	114	16 IR	1.60	WGB.ER1.001.000	WGB.ER2.001.012 (2.0 Nm)	WGB.ER2.102.003	WGB.ER3.001.007 (2.0 Nm)
HA6.BGB.LGA.140	T63	27	40	50	140	114	16 IL	1.60	WGB.ER1.001.000	WGB.ER2.001.012 (2.0 Nm)	WGB.ER2.101.003	WGB.ER3.001.007 (2.0 Nm)
HA0.BGB.RGA.150	T100	27	40	50	150	121	16 IR	2.98	WGB.ER1.001.000	WGB.ER2.001.012 (2.0 Nm)	WGB.ER2.102.003	WGB.ER3.001.007 (2.0 Nm)
HA0.BGB.LGA.150	T100	27	40	50	150	121	16 IL	2.98	WGB.ER1.001.000	WGB.ER2.001.012 (2.0 Nm)	WGB.ER2.101.003	WGB.ER3.001.007 (2.0 Nm)

Wechselschneidköpfe für
Innengewinde

Exchangeable cutting heads for
Internal thread

Têtes de coupe interchangeables
pour le filetage interne

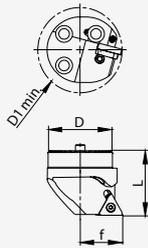

Bestell-Nr. / Order number/ Code	D	D1 min.	f	L	Wendeplatte/ Insert/ Plaquette	kg				
WK5.BGB.RGY.020	16	22	12	20	16 IR	0.05	WCA.ER1.001.000	WCA.ER2.001.006 (0.9 Nm)		
WK5.BGB.LGY.020	16	22	12	20	16 IL	0.05	WCA.ER1.001.000	WCA.ER2.001.006 (0.9 Nm)		
WK4.BGB.RGZ.025	20	25	14	25	16 IR	0.08	WGB.ER1.001.000	WGB.ER2.001.012 (2.0 Nm)		
WK4.BGB.LGZ.025	20	25	14	25	16 IL	0.08	WGB.ER1.001.000	WGB.ER2.001.012 (2.0 Nm)		
WK3.BGB.RGA.035	25	32	17	35	16 IR	0.10	WGB.ER1.001.000	WGB.ER2.001.012 (2.0 Nm)	WGB.ER2.102.003	WGB.ER3.001.007 (2.0 Nm)
WK3.BGB.LGA.035	25	32	17	35	16 IL	0.10	WGB.ER1.001.000	WGB.ER2.001.012 (2.0 Nm)	WGB.ER2.101.003	WGB.ER3.001.007 (2.0 Nm)
WK2.BGB.RGB.035	32	40	22	40	16 IR	0.18	WGB.ER1.001.000	WGB.ER2.001.012 (2.0 Nm)	WGB.ER2.102.003	WGB.ER3.001.007 (2.0 Nm)
WK2.BGB.LGB.035	32	40	22	40	16 IL	0.18	WGB.ER1.001.000	WGB.ER2.001.012 (2.0 Nm)	WGB.ER2.101.003	WGB.ER3.001.007 (2.0 Nm)
WK1.BGB.RGC.040	40	50	27	40	16 IR	0.30	WGB.ER1.001.000	WGB.ER2.001.012 (2.0 Nm)	WGB.ER2.102.003	WGB.ER3.001.007 (2.0 Nm)
WK1.BGB.LGC.040	40	50	27	40	16 IL	0.30	WGB.ER1.001.000	WGB.ER2.001.012 (2.0 Nm)	WGB.ER2.101.003	WGB.ER3.001.007 (2.0 Nm)

Bohrstangen mit Wechselschneidköpfen

- für effiziente Drehbearbeitung
- optimale Kühlung durch ausgerichtete Kühldüse und Hochdruckkühldüse



Boring bars with exchangeable cutting heads

- to turn efficiently
- optimal cooling by adjusted cooling nozzle and high pressure cooling nozzle

Barres d'alésage avec têtes de coupe interchangeables

- pour des opérations de tournage efficaces
- arrosage optimal par des buses d'arrosage fixes High Pressure



Bohrstangenschäfte

Boring bar shanks

Barres d'alésage

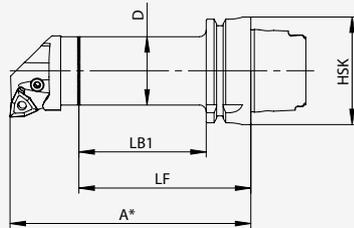

Bestell-Nr. / Order number/ Code	HSK	D	A*	LF	LB1	kg	
HA4.WK3.025.090	T40	25	90	55	35	0.32	NI4.762.004.012
HA4.WK3.025.110	T40	25	110	75	55	0.39	NI4.762.004.012
HA4.WK2.032.115	T40	32	115	80	60	0.55	NI4.762.004.012
HA4.WK1.040.120	T40	40	120	80	-	0.71	NI4.762.005.014
HA6.WK5.016.076	T63	16	76	56	36	0.80	NI4.762.003.010
HA6.WK4.020.100	T63	20	100	80	60	0.80	NI4.762.035.012
HA6.WK3.025.105	T63	25	105	80	44	0.80	NI4.762.004.012
HA6.WK2.032.125	T63	32	125	100	64	1.05	NI4.762.005.014
HA6.WK2.032.160	T63	32	160	125	99	1.23	NI4.762.005.014
HA6.WK1.040.140	T63	40	140	100	74	1.34	NI4.762.006.016
HA6.WK1.040.180	T63	40	180	140	114	1.71	NI4.762.006.016
HA0.WK2.032.160	T100	32	160	125	95	2.55	NI4.762.005.014
HA0.WK1.040.110	T100	40	110	70	41	2.38	NI4.762.006.016
HA0.WK1.040.180	T100	40	180	140	111	3.05	NI4.762.006.016

Bohrstangenschäfte mit Zylinderschaft

- Anschlussgewinde für Innenkühlung
- 3 Spannflächen

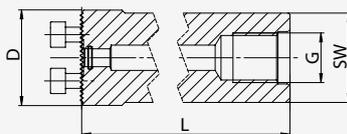

Boring bar shanks with cylindrical shank

- with thread for inner coolant supply
- 3 clamping flats

Barres d'alésage avec tige cylindrique

- Filet pour l'arrosage interne
- 3 surfaces de serrage



Bestell-Nr. / Order number/ Code	D	L	SW	G	kg	
U25.WK3.025.200	25	200	23	G1/4	0.65	NI4.762.004.012
U32.WK2.032.218	32	218	30	G3/8	1.22	NI4.762.005.014
U40.WK1.040.283	40	283	37	G1/2	2.46	NI4.762.006.016

**Schwingungsgedämpfte
Bohrstangenschäfte (HM-Kern)**

**Damped
boring bar shanks (carbide core)**

**Tiges de barres
d'alésage anti-vibrations**

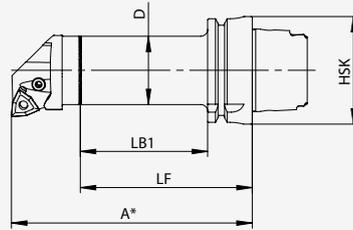

Bestell-Nr. / Order number/ Code	HSK	D	A*	LF	LB1	kg	
HA6.WK3.025.150	T63	25	150	115	89	0.98	NI4.762.004.012
HA6.WK2.032.185	T63	32	185	150	124	1.76	NI4.762.005.014
HA6.WK1.040.225	T63	40	225	185	159	2.20	NI4.762.006.016

**Schwingungsgedämpfte
Bohrstangenschäfte
Tilgersystem / Massendämpfer**

**Damped
boring bar shanks
Tilger system / Mass damper**

**Tiges de barres
d'alésage anti-vibrations
Système Tilger / Amortisseur masse**

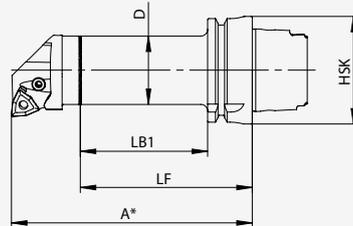

Bestell-Nr. / Order number/ Code	HSK	D	A*	LF	LB1	kg	
HA6.WK5.WD0.110	T63	16	110	90	64	1.01	NI4.762.003.010
HA6.WK4.WD1.126	T63	20	126	106	80	1.00	NI4.762.035.012
HA6.WK3.WD2.161	T63	25	161	126	100	1.50	NI4.762.004.012
HA6.WK3.WD2.186	T63	25	186	151	125	1.60	NI4.762.004.012
HA6.WK2.WD3.189	T63	32	189	154	128	1.80	NI4.762.005.014
HA6.WK2.WD3.221	T63	32	221	186	160	2.22	NI4.762.005.014
HA6.WK1.WD4.226	T63	40	226	186	160	2.60	NI4.762.006.016
HA6.WK1.WD4.266	T63	40	266	226	200	3.95	NI4.762.006.016

SCLC R/L

K_r 95° (-5°)

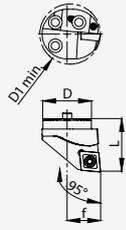

PCLN R/L

K_r 95° (-5°)

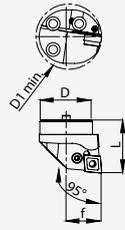

Typ/ Type/ Type	Bestell-Nr./ Order number/ Code	D	D1 min.	f	L	Wendeplatte/ Insert/ Plaquette	kg				
SCLCR/L	WK5.BCA.(R/L)LY.020	16	20	11	20	CC..06 02..	0.05	WCA.ER1.001.000	WCA.ER2.001.006 (0.9 Nm)		
SCLCR/L	WK4.BCB.(R/L)LZ.020	20	25	13	20	CC..09 T3..	0.08	WCB.ER1.001.000	WCB.ER2.001.009 (3.0 Nm)		
SCLCR/L	WK3.BCB.(R/L)LA.035	25	32	17	35	CC..09 T3..	0.10	WCB.ER1.001.000	WCB.ER2.001.009 (3.0 Nm)		
SCLCR/L	WK3.BCC.(R/L)LA.035	25	32	17	35	CC..12 04..	0.10	WCC.ER1.001.000	WCC.ER2.001.010 (5.0 Nm)		
SCLCR/L	WK2.BCC.(R/L)LB.035	32	40	22	35	CC..12 04..	0.20	WCC.ER1.001.000	WCC.ER2.001.010 (5.0 Nm)		
SCLCR/L	WK1.BCC.(R/L)LC.040	40	50	27	40	CC..12 04..	0.30	WCC.ER1.001.000	WCC.ER2.001.010 (5.0 Nm)		
											
PCLN R/L	WK3.PCD.(R/L)LA.035	25	32	17	35	CN..12 04..	0.10	WCD.ER2.101.003	WCD.ER4.101.017 (5.0 Nm)	WCD.ER3.101.000	WCD.ER1.101.000
PCLN R/L	WK2.PCD.(R/L)LB.035	32	40	22	35	CN..12 04..	0.20	WCD.ER2.101.003	WCD.ER4.101.017 (5.0 Nm)	WCD.ER3.101.000	WCD.ER1.101.000
PCLN R/L	WK1.PCD.(R/L)LC.040	40	50	27	40	CN..12 04..	0.30	WCD.ER2.101.003	WCD.ER4.101.017 (5.0 Nm)	WCD.ER3.101.000	WCD.ER1.101.000

SVPB R/L

K_r 117.5° (-27.5°)

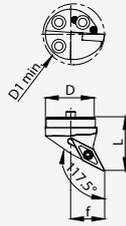
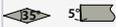

SVUB R/L

K_r 93° (-3°)

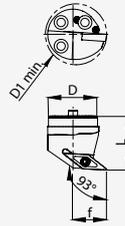

SVQB R/L

K_r 107.5° (-17.5°)

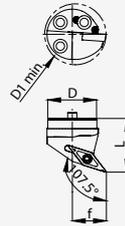

Typ/ Type/ Type	Bestell-Nr./ Order number/ Code	D	D1 min.	f	L	Wendeplatte/ Insert/ Plaquette	kg		
SVPB R/L	WK3.BVE.(R/L)PA.035	25	32	17	35	VB..11 03..	0.10	WCB.ER1.001.000	WCB.ER2.001.009 (3.0 Nm)
SVPB R/L	WK2.BVF.(R/L)PB.035	32	40	22	35	VB..16 04..	0.20	WCB.ER1.001.000	WCB.ER2.001.009 (3.0 Nm)
SVPB R/L	WK1.BVF.(R/L)PC.040	40	50	27	40	VB..16 04..	0.30	WCB.ER1.001.000	WCB.ER2.001.009 (3.0 Nm)
SVUB R/L	WK4.BVE.(R/L)UZ.020	20	27	16	20	VB..11 03..	0.08	WCB.ER1.001.000	WCB.ER2.001.009 (3.0 Nm)
SVUB R/L	WK3.BVE.(R/L)UA.035	25	32	17	35	VB..11 03..	0.10	WCB.ER1.001.000	WCB.ER2.001.009 (3.0 Nm)
SVUB R/L	WK2.BVF.(R/L)UB.035	32	40	22	35	VB..16 04..	0.20	WCB.ER1.001.000	WCB.ER2.001.009 (3.0 Nm)
SVUB R/L	WK1.BVF.(R/L)UC.040	40	50	27	40	VB..16 04..	0.30	WCB.ER1.001.000	WCB.ER2.001.009 (3.0 Nm)
SVQB R/L	WK4.BVE.(R/L)QZ.020	20	27	15	20	VB..11 03..	0.08	WCB.ER1.001.000	WCB.ER2.001.009 (3.0 Nm)
SVQB R/L	WK3.BVE.(R/L)QA.035	25	32	17	35	VB..11 03..	0.10	WCB.ER1.001.000	WCB.ER2.001.009 (3.0 Nm)
SVQB R/L	WK2.BVF.(R/L)QB.035	32	40	22	35	VB..16 04..	0.20	WCB.ER1.001.000	WCB.ER2.001.009 (3.0 Nm)
SVQB R/L	WK1.BVF.(R/L)QC.040	40	50	27	40	VB..16 04..	0.30	WCB.ER1.001.000	WCB.ER2.001.009 (3.0 Nm)

SDUC R/L

K_r 93° (-3°)

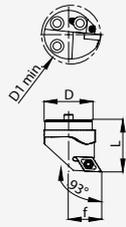

SDQC R/L

K_r 107.5° (-17.5°)

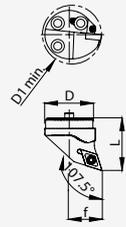

PDUN R/L

K_r 93° (-3°)



PDQN R/L

K_r 107.5° (-17.5°)



Typ/ Type/ Type	Bestell-Nr. / Order number/ Code	D	D1 min.	f	L	Wendeplatte/ Insert/ Plaquette	kg				
SDUC R/L	WK5.BDA.(R/L)UY.020	16	20	11	20	DC..07 02..	0.05	WCA.ER1.001.000	WCA.ER2.001.006 (0.9 Nm)		
SDUC R/L	WK4.BDB.(R/L)UZ.020	20	25	13	20	DC..11 T3..	0.08	WCB.ER1.001.000	WCB.ER2.001.009 (3.0 Nm)		
SDUC R/L	WK3.BDB.(R/L)UA.035	25	32	17	35	DC..11 T3..	0.10	WCB.ER1.001.000	WCB.ER2.001.009 (3.0 Nm)		
SDUC R/L	WK2.BDB.(R/L)UB.035	32	40	22	35	DC..11 T3..	0.20	WCB.ER1.001.000	WCB.ER2.001.009 (3.0 Nm)		
SDUC R/L	WK1.BDB.(R/L)UC.040	40	50	27	40	DC..11 T3..	0.30	WCB.ER1.001.000	WCB.ER2.001.009 (3.0 Nm)		
SDQC R/L	WK4.BDB.(R/L)QZ.020	20	25	13	20	DC..11 T3..	0.08	WCB.ER1.001.000	WCB.ER2.001.009 (3.0 Nm)		
SDQC R/L	WK3.BDB.(R/L)QA.035	25	32	17	35	DC..11 T3..	0.10	WCB.ER1.001.000	WCB.ER2.001.009 (3.0 Nm)		
SDQC R/L	WK2.BDB.(R/L)QB.035	32	40	22	35	DC..11 T3..	0.20	WCB.ER1.001.000	WCB.ER2.001.009 (3.0 Nm)		
SDQC R/L	WK1.BDB.(R/L)QC.040	40	50	27	40	DC..11 T3..	0.30	WCB.ER1.001.000	WCB.ER2.001.009 (3.0 Nm)		
PDUN R/L	WK3.PDE.(R/L)UA.035	25	32	17	35	DN..11 04..	0.10	WDE.ER2.101.003	WDE.ER4.101.017 (5.0 Nm)	WDE.ER3.101.000	WDE.ER1.101.000
PDUN R/L	WK2.PDE.(R/L)UB.035	32	40	22	35	DN..11 04..	0.20	WDE.ER2.101.003	WDE.ER4.101.017 (5.0 Nm)	WDE.ER3.101.000	WDE.ER1.101.000
PDUN R/L	WK1.PDE.(R/L)UC.040	40	50	27	40	DN..11 04..	0.30	WDE.ER2.101.003	WDE.ER4.101.017 (5.0 Nm)	WDE.ER3.101.000	WDE.ER1.101.000
PDUN R/L	WK2.PDF.(R/L)UB.035	32	40	22	35	DN..15 06..	0.20	WDF.ER2.101.003	WCD.ER4.101.017 (5.0 Nm)	WDF.ER3.101.000	WCD.ER1.101.000
PDUN R/L	WK1.PDF.(R/L)UC.040	40	50	27	40	DN..15 06..	0.30	WDF.ER2.101.003	WCD.ER4.101.017 (5.0 Nm)	WDF.ER3.101.000	WCD.ER1.101.000
PDQN R/L	WK3.PDE.(R/L)QA.035	25	32	17	35	DN..11 04..	0.10	WDE.ER2.101.003	WDE.ER4.101.017 (5.0 Nm)	WDE.ER3.101.000	WDE.ER1.101.000
PDQN R/L	WK2.PDE.(R/L)QB.035	32	40	22	35	DN..11 04..	0.20	WDE.ER2.101.003	WDE.ER4.101.017 (5.0 Nm)	WDE.ER3.101.000	WDE.ER1.101.000
PDQN R/L	WK1.PDE.(R/L)QC.040	40	50	27	40	DN..11 04..	0.30	WDE.ER2.101.003	WDE.ER4.101.017 (5.0 Nm)	WDE.ER3.101.000	WDE.ER1.101.000

PWLN R/L

K_r 95° (-5°)

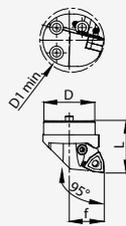

Typ/ Type/ Type	Bestell-Nr. / Order number/ Code	D	D1 min.	f	L	Wendeplatte/ Insert/ Plaquette	kg				
PWLN R/L	WK2.PWE.(R/L)LB.035	32	40	22	35	WN..08 04..	0.20	WWE.ER2.101.004	WCD.ER4.101.017 (5.0 Nm)	WDF.ER3.101.000	WCD.ER1.101.000
PWLN R/L	WK1.PWE.(R/L)LC.040	40	50	27	40	WN..08 04..	0.30	WWE.ER2.101.004	WCD.ER4.101.017 (5.0 Nm)	WDF.ER3.101.000	WCD.ER1.101.000

SCLC R/L 95°/80°

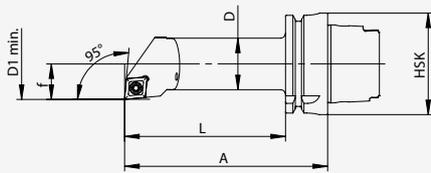
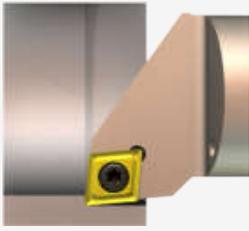

Bestell-Nr. / Order number/ Code	HSK	f	D	D1 min.	A	L	Wendeplatte/ Insert/ Plaquette	kg		
HA4.BCC.(R/L)LA.110	T40	17	25	32	110	90	CC..12 04..	0.45	WCC.ER1.001.000	WCC.ER2.001.010 (5.0 Nm)
HA4.BCC.(R/L)LA.140	T40	17	25	32	140	120	CC..12 04..	1.54	WCC.ER1.001.000	WCC.ER2.001.010 (5.0 Nm)
HA6.BCC.(R/L)LB.125	T63	22	32	40	125	99	CC..12 04..	1.12	WCC.ER1.001.000	WCC.ER2.001.010 (5.0 Nm)
HA6.BCC.(R/L)LB.160	T63	22	32	40	160	134	CC..12 04..	1.33	WCC.ER1.001.000	WCC.ER2.001.010 (5.0 Nm)
HA6.BCC.(R/L)LC.140	T63	27	40	50	140	114	CC..12 04..	1.54	WCC.ER1.001.000	WCC.ER2.001.010 (5.0 Nm)
HA6.BCC.(R/L)LC.180	T63	27	40	50	180	154	CC..12 04..	1.90	WCC.ER1.001.000	WCC.ER2.001.010 (5.0 Nm)

PCLN R/L 95°/80°

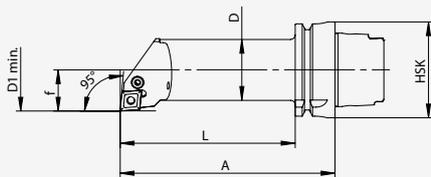
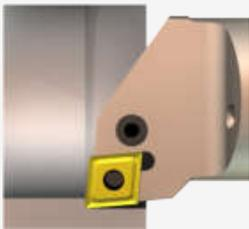

Bestell-Nr. / Order number/ Code	HSK	f	D	D1 min.	A	L	Wendeplatte/ Insert/ Plaquette	kg				
HA6.PCD.(R/L)LC.140	T63	27	40	50	140	114	CN..12 04..	1.56	WCD.ER2.101.003	WCD.ER4.101.017 (5.0 Nm)	WCD.ER3.101.000	WCD.ER1.101.000
HA6.PCD.(R/L)LC.180	T63	27	40	50	180	154	CN..12 04..	1.94	WCD.ER2.101.003	WCD.ER4.101.017 (5.0 Nm)	WCD.ER3.101.000	WCD.ER1.101.000
HA0.PCD.(R/L)LC.150	T100	27	40	50	150	121	CN..12 04..	2.94	WCD.ER2.101.003	WCD.ER4.101.017 (5.0 Nm)	WCD.ER3.101.000	WCD.ER1.101.000
HA0.PCD.(R/L)LC.200	T100	27	40	50	200	171	CN..12 04..	3.39	WCD.ER2.101.003	WCD.ER4.101.017 (5.0 Nm)	WCD.ER3.101.000	WCD.ER1.101.000
HA0.PCD.(R/L)LD.150	T100	35	50	63	150	121	CN..12 04..	3.52	WCD.ER2.101.003	WCD.ER4.101.017 (5.0 Nm)	WCD.ER3.101.000	WCD.ER1.101.000
HA0.PCD.(R/L)LD.200	T100	35	50	63	200	171	CN..12 04..	4.24	WCD.ER2.101.003	WCD.ER4.101.017 (5.0 Nm)	WCD.ER3.101.000	WCD.ER1.101.000

SDQC R/L 107.5°/55°

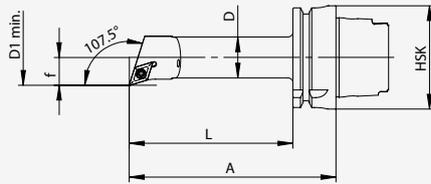
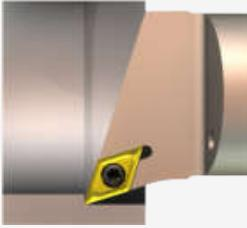

Bestell-Nr. / Order number/ Code	HSK	f	D	D1 min.	A	L	Wendeplatte/ Insert/ Plaquette	kg		
HA4.BDB.(R/L)LA.110	T40	17	25	32	110	90	DC...11T3..	0.46	WCB.ER1.001.000	WCB.ER2.001.009 (3.0 Nm)
HA4.BDB.(R/L)LA.140	T40	17	25	32	140	120	DC...11T3..	0.48	WCB.ER1.001.000	WCB.ER2.001.009 (3.0 Nm)
HA6.BDB.(R/L)QB.125	T63	22	32	40	125	99	DC...11T3..	1.12	WCB.ER1.001.000	WCB.ER2.001.009 (3.0 Nm)
HA6.BDB.(R/L)QB.160	T63	22	32	40	160	134	DC...11T3..	1.32	WCB.ER1.001.000	WCB.ER2.001.009 (3.0 Nm)
HA6.BDB.(R/L)QC.140	T63	27	40	50	140	114	DC...11T3..	1.54	WCB.ER1.001.000	WCB.ER2.001.009 (3.0 Nm)
HA6.BDB.(R/L)QC.180	T63	27	40	50	180	154	DC...11T3..	1.92	WCB.ER1.001.000	WCB.ER2.001.009 (3.0 Nm)

PDQN R/L 107.5°/55°

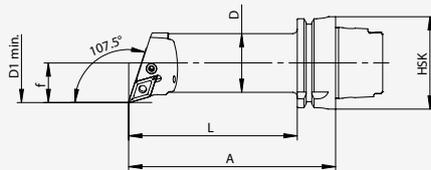
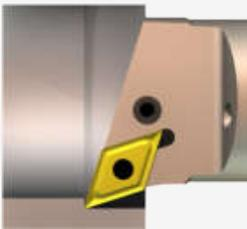

Bestell-Nr. / Order number/ Code	HSK	f	D	D1 min.	A	L	Wendeplatte/ Insert/ Plaquette	kg				
HA6.PDF.(R/L)QC.140	T63	27	40	50	140	114	DN...15 06...*	1.56	WDF.ER2.101.003	WCD.ER4.101.017 (5.0 Nm)	WDF.ER3.101.000	WCD.ER1.101.000
HA6.PDF.(R/L)QC.180	T63	27	40	50	180	154	DN...15 06...*	1.94	WDF.ER2.101.003	WCD.ER4.101.017 (5.0 Nm)	WDF.ER3.101.000	WCD.ER1.101.000
HA0.PDF.(R/L)QC.150	T100	27	40	50	150	121	DN...15 06...*	2.94	WDF.ER2.101.003	WCD.ER4.101.017 (5.0 Nm)	WDF.ER3.101.000	WCD.ER1.101.000
HA0.PDF.(R/L)QC.200	T100	27	40	50	200	171	DN...15 06...*	3.40	WDF.ER2.101.003	WCD.ER4.101.017 (5.0 Nm)	WDF.ER3.101.000	WCD.ER1.101.000
HA0.PDF.(R/L)QD.150	T100	35	50	63	150	121	DN...15 06...*	3.50	WDF.ER2.101.003	WCD.ER4.101.017 (5.0 Nm)	WDF.ER3.101.000	WCD.ER1.101.000
HA0.PDF.(R/L)QD.200	T100	35	50	63	200	171	DN...15 06...*	4.23	WDF.ER2.101.003	WCD.ER4.101.017 (5.0 Nm)	WDF.ER3.101.000	WCD.ER1.101.000

* DN...15 04... möglich mit Unterlegplatte
WDF.ER2.101.004

* DN...15 04... possible with tip pad
WDF.ER2.101.004

* DN...15 04... possible avec plateau de
support WDF.ER2.101.004

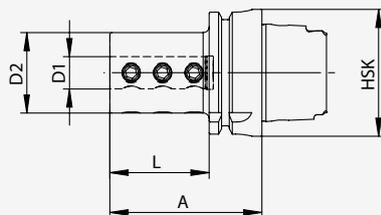

Bestell-Nr. / Order number/ Code	HSK	D1	D2	A	L	kg	
HA4.B06.K01.055	T40	6	34	55	35	0.4	ERU.GS4.001.010 (5.0 Nm) M 6 x 10
HA4.B08.K01.055	T40	8	34	55	35	0.38	ERU.GS5.001.010 (10.0 Nm) M 8 x 10
HA4.B10.K01.055	T40	10	34	55	35	0.37	ERU.GS5.001.010 (10.0 Nm) M 8 x 10
HA4.B12.K01.055	T40	12	36	55	35	0.36	ERU.GS5.001.010 (10.0 Nm) M 8 x 10
HA4.B16.K01.070	T40	16	40	70	50	0.4	ERU.GS6.001.012 (15.0 Nm) M10 x 12
HA4.B20.K01.085	T40	20	44	85	65	0.71	ERU.GS6.001.012 (15.0 Nm) M10 x 12
HA4.B25.So1.070	T40	25	50	85	-	0.60	ERU.GS6.001.012 (15.0 Nm) M10 x 12
HA6.B06.K01.060	T63	6	34	60	34	0.86	ERU.GS4.001.010 (5.0 Nm) M 6 x 10
HA6.B08.K01.060	T63	8	34	60	34	0.86	ERU.GS5.001.010 (10.0 Nm) M 8 x 10
HA6.B10.K01.060	T63	10	34	60	34	0.86	ERU.GS5.001.010 (10.0 Nm) M 8 x 10
HA6.B12.K01.060	T63	12	36	60	34	0.85	ERU.GS5.001.010 (10.0 Nm) M 8 x 10
HA6.B16.K01.075	T63	16	40	75	49	0.99	ERU.GS6.001.012 (15.0 Nm) M10 x 12
HA6.B20.K01.075	T63	20	44	75	49	1.05	ERU.GS6.001.012 (15.0 Nm) M10 x 12
HA6.B25.K01.075	T63	25	50	75	49	1.2	ERU.GS6.001.012 (15.0 Nm) M10 x 12
HA6.B32.K01.090	T63	32	56	90	64	1.36	ERU.GS6.001.012 (15.0 Nm) M10 x 12
HA6.B40.K01.090	T63	40	63	90	64	1.37	ERU.GS6.001.012 (15.0 Nm) M10 x 12
HA0.B06.K01.070	T100	6	34	70	41	2.26	ERU.GS4.001.010 (5.0 Nm) M 6 x 10
HA0.B08.K01.070	T100	8	34	70	41	2.24	ERU.GS5.001.010 (10.0 Nm) M 8 x 10
HA0.B10.K01.070	T100	10	34	70	41	2.36	ERU.GS5.001.010 (10.0 Nm) M 8 x 10
HA0.B12.K01.070	T100	12	36	70	41	2.38	ERU.GS5.001.010 (10.0 Nm) M 8 x 10
HA0.B16.K01.085	T100	16	40	85	56	2.41	ERU.GS6.001.012 (15.0 Nm) M10 x 12
HA0.B20.K01.085	T100	20	44	85	56	2.49	ERU.GS6.001.012 (15.0 Nm) M10 x 12
HA0.B25.K01.085	T100	25	50	85	56	2.6	ERU.GS6.001.012 (15.0 Nm) M10 x 12
HA0.B32.K01.100	T100	32	56	100	71	2.89	ERU.GS6.001.012 (15.0 Nm) M10 x 12
HA0.B40.K01.100	T100	40	63	100	71	3.02	ERU.GS6.001.012 (15.0 Nm) M10 x 12

**Schwingungsgedämpfte
Bohrstangenhalter**

**Damped
Boring bar holder**

**Tiges de porte-outils
d'alésage anti-vibrations**

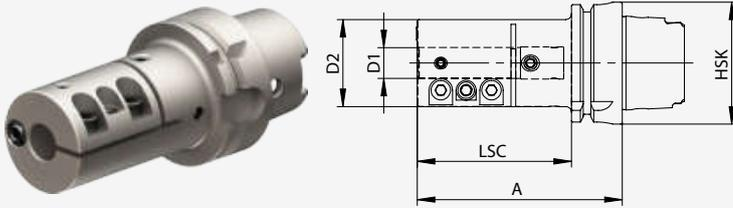

Bestell-Nr. / Order number/ Code	HSK	D1	D2	A	LSC	kg					
HA6.B10.K21.105	T63	10	45	105	65	1.48	Ni4.027.006.016	Ni4.028.008.016	Ni4.028.010.016	Ni4.762.006.016	KU1.U12.002.010
HA6.B12.K21.105	T63	12	45	105	65	1.46	Ni4.027.006.016	Ni4.028.008.016	Ni4.028.010.016	Ni4.762.006.016	KU1.U12.002.010
HA6.B16.K21.105	T63	16	45	105	75	1.41	Ni4.027.006.016	Ni4.028.008.016	Ni4.028.010.016	Ni4.762.006.016	KU1.U12.002.010
HA6.B20.K21.105	T63	20	55	105	80	1.76	Ni4.027.006.016	Ni4.028.008.016	Ni4.028.010.016	Ni4.762.006.016	KU1.U12.002.010
HA6.B25.K21.105	T63	25	55	105	80	1.66	Ni4.027.006.016	Ni4.028.008.016	Ni4.028.010.016	Ni4.762.006.016	KU1.U12.002.010
HA6.B32.K21.105	T63	32	65	105	80	1.66	Ni4.027.006.016	Ni4.028.008.016	Ni4.028.010.016	Ni4.762.006.016	KU1.U12.002.010

• mehr Stabilität und schwingungsdämpfende Wirkung durch Umschlingung der Bohrstange

• more stability and vibration dampening effect by wrapping around the boring bar

* plus de stabilité et un effet d'amortissement des vibrations en s'enroulant autour de la barre d'alésage

**Werkzeughalter für
Wendeplattenbohrer**

**Toolholder for
indexable insert drills**

**Porte-outils pour fraises
à plaquettes indexables**

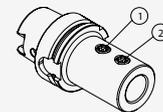
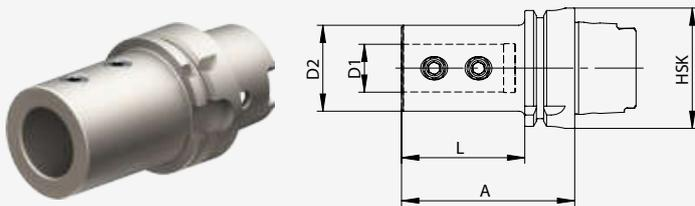

Bestell-Nr. / Order number/ Code	HSK	D1	D2	A	L	kg		
HA6.K20.K01.080	T63	20	40	80	48	1.03	K20.ER1.010.012	K20.ER2.010.014
HA6.K25.K01.090	T63	25	45	90	50	1.2	K20.ER1.010.012	K20.ER2.010.014
HA6.K32.K01.090	T63	32	52	90	53	1.3	K32.ER1.012.012	K32.ER2.012.014
HA6.K40.K01.105	T63	40	60	105	-	1.54	K40.ER1.016.012	K40.ER2.016.014
HA0.K20.K01.090	T100	20	40	90	48	2.60	K20.ER1.010.012	K20.ER2.010.014
HA0.K25.K01.095	T100	25	45	95	50	2.70	K20.ER1.010.012	K20.ER2.010.014
HA0.K32.K01.100	T100	32	52	100	53	2.80	K32.ER1.012.012	K32.ER2.012.014
HA0.K40.K01.110	T100	40	60	110	-	3.00	K40.ER1.016.012	K40.ER2.016.014

• zum Spannen von Zylinderschäften nach DIN 6595-1 / ISO 9766

• to clamp cylindrical shanks DIN 6595-1 / ISO 9766

* pour le serrage de tiges cylindriques selon DIN 6595-1 / ISO 9766

Abstechhalter radial mit ECO / Direct Coolant

Cut-off block radial with ECO / direct coolant

Bloc de tronçonnage radial ECO / direct coolant

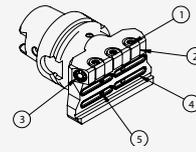
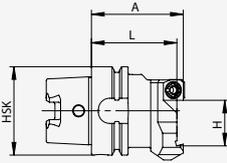
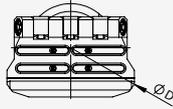

Bestell-Nr. / Order number/ Code	HSK	A	H	L	ØD	rechts/links right/left droite/gauche	kg	1	2	3	4	5
HA4.AE2.N11.065-HP	T40	65	26	60.5	90	R/L	0.95	AE3.ER1.006.028	AE3.ER1.011.014	KU1.U12.002.010	ND3.771.023.001	NI4.026.004.004
HA6.AE3.N11.065-HP	T63	65	32	60.5	100	R/L	1.50	AE3.ER1.006.028	AE3.ER1.011.014	KU1.U12.002.010	ND3.771.025.001	NI4.026.004.004

- zur Aufnahme von Stechschwertern
- mit Innenkühlung
- mit ECO / direct coolant

- to hold cut-off blades
- with inner coolant supply
- with ECO / direct coolant

- pour tenir les lames de coupe
- avec arrosage interne
- ECO / direct coolant

Abstechhalter radial

Cut-off block radial

Bloc de tronçonnage radial

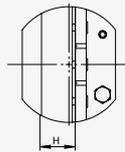
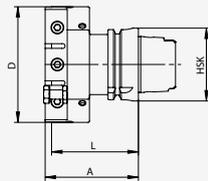

Bestell-Nr. / Order number/ Code	HSK	A	H	L	ØD	rechts/links right/left droite/gauche	kg	
HA4.AM2.K11.075	T40	75	26	70	100	R/L	1.33	NI4.762.006.016
HA6.AM3.K11.080	T63	80	32	75	100	R/L	3.25	NI4.762.006.016
HA0.AM3.K11.085	T100	85	32	80	100	R/L	4.50	NI4.762.006.016

- zur Aufnahme von Stechschwertern
- mit Innenkühlung

- to hold cut-off blades
- with inner coolant supply

- pour tenir les lames de coupe
- avec arrosage interne

**Abstechhalter axial
mit ECO / Direct Coolant**

**Cut-off block axial
with ECO / direct coolant**

**Bloc de tronçonnage axial
ECO / direct coolant**

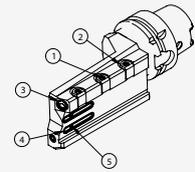
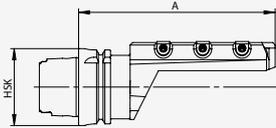
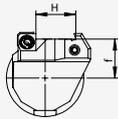

Bestell-Nr. / Order number/ Code	HSK	f	A	H	ØD	rechts/links right/left droite/gauche	kg	1	2	3	4	5
HA4.AE2.R11.122-HP	T40	21	122	26	80	R	0.95	AE3.ER1.006.028	AE3.ER1.011.014	KU1.U12.002.010	ND3.771.023.001	NI4.026.004.004
HA4.AE2.L11.122-HP	T40	21	122	26	80	L	0.95	AE3.ER1.006.028	AE3.ER1.011.014	KU1.U12.002.010	ND3.771.023.001	NI4.026.004.004
HA6.AE3.R11.160-HP	T63	22	160	32	105	R	2.10	AE3.ER1.006.028	AE3.ER1.011.014	KU1.U12.002.010	ND3.771.025.001	NI4.026.004.004
HA6.AE3.L11.160-HP	T63	22	160	32	105	L	2.1	AE3.ER1.006.028	AE3.ER1.011.014	KU1.U12.002.010	ND3.771.025.001	NI4.026.004.004

- zur Aufnahme von Stechschwertern
- mit Innenkühlung
- mit ECO / direct coolant

- to hold cut-off blades
- with inner coolant supply
- with ECO / direct coolant

- pour tenir les lames de coupe
- avec arrosage interne
- ECO / direct coolant

**Abstechhalter axial
mit ECO / Direct Coolant**

**Cut-off block axial
with ECO / direct coolant**

**Bloc de tronçonnage axial
ECO / direct coolant**

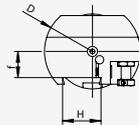
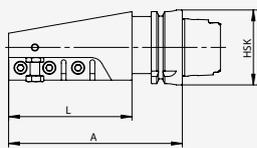

Bestell-Nr. / Order number/ Code	HSK	f	A	H	L	ØD	rechts/links right/left droite/gauche	kg	
HA6.AM3.K11.145	T63	22	145	32	105	80	R	3.30	NI4.762.006.016
HA6.AM3.K12.145	T63	22	145	32	105	80	L	3.30	NI4.762.006.016
HA0.AM3.K11.150	T100	30	150	32	105	90	R	6.90	NI4.762.006.016
HA0.AM3.K12.150	T100	30	150	32	105	90	L	6.90	NI4.762.006.016

- zur Aufnahme von Stechschwertern
- mit Innenkühlung
- mit ECO / direct coolant

- to hold cut-off blades
- with inner coolant supply
- with ECO / direct coolant

- pour tenir les lames de coupe
- avec arrosage interne
- ECO / direct coolant

**Werkzeughalter radial
mit ECO / Direct Coolant**

**Tool holder radial
with ECO / direct coolant**

**Porte-outil radial
ECO / direct coolant**

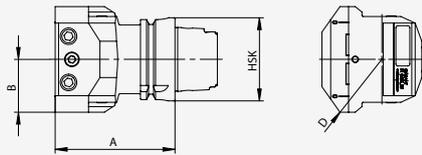

Bestell-Nr. / Order number/ Code	HSK	B	Vier- kant Square	A	D	kg					
HA6.V2X.N11.090-HP	T63	40	25x25 20x20*	90	102	2.60	NI4.026.012.016	KU1.U12.002.010	V2X.ER1.025.055	V2X.ER1.025.080	NI4.762.006.016

- für effiziente Drehbearbeitung
- optimale Kühlung durch einstellbare Hochdruck Kugelspritzdüsen
- mit ECO / direct coolant
- Kühlmittelübergabe zum Werkzeugschaft
- * Unterlegplatte für Schaft 20x20 nicht im Lieferumfang enthalten

- to turn efficiently
- optimal cooling through adjustable high pressure ball spray nozzles
- with ECO / direct coolant
- coolant transfer into tool shank
- * shim for shaft 20x20 not included in delivery

- pour un tournage efficace
- refroidissement optimal grâce à des buses de pulvérisation à bille haute pression réglables
- avec ECO / direct coolant
- Transfert de liquide de refroidissement vers la queue de l'outil
- * Plaque de rondelle pour arbre 20x20 non comprise dans la livraison

Werkzeughalter radial

Tool holder radial

Porte-outil radial

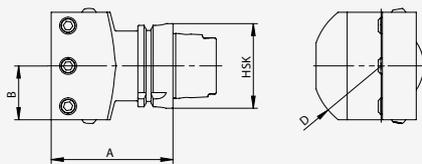

Bestell-Nr. / Order number/ Code	HSK	B	Vier- kant Square	A	D	kg		
HA4.V20.N11.075	T40	30	20x20	75	80	0.87	NI4.026.010.020	KU1.U12.001.010
HA6.V20.N11.090	T63	30	20x20	90	80	1.16	NI4.026.010.020	KU1.U12.001.010
HA6.V25.N11.090	T63	40	25x25	90	102	1.16	NI4.026.012.020	KU1.U12.001.010
HA0.V25.N11.100	T100	50	25x25	100	122	1.55	NI4.026.010.020	KU1.U12.001.010
HA0.V32.N11.100	T100	50	32x32	100	122	2.31	NI4.026.012.025	KU1.U12.001.010

**Werkzeughalter axial
mit ECO / Direct Coolant**

**Tool holder axial
with ECO / direct coolant**

**Porte-outil axial
ECO / direct coolant**

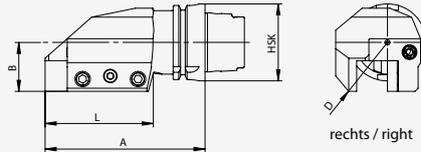

Bestell-Nr. / Order number/ Code	HSK	B	Vier- kant Square	A	L	ØD	kg					
HA6.V2X.(R/L)11.130-HP	T63	40	25x25 20x20*	130	88	100	2.60	NI4.026.012.016	KU1.U12.002.010	V2X.ER1.025.066	V2X.ER2.025.082(R) V2X.ER1.025.082(L)	NI4.762.006.016

- für effiziente Drehbearbeitung
- optimale Kühlung durch einstellbare Hochdruck Kugelspritzdüsen
- mit ECO / direct coolant
- Kühlmittelübergabe zum Werkzeugschaft
- * Unterlegplatte für Schaft 20x20 nicht im Lieferumfang enthalten

- to turn efficiently
- optimal cooling through adjustable high pressure ball spray nozzles
- with ECO / direct coolant
- coolant transfer into tool shank
- * shim for shaft 20x20 not included in delivery

- pour un tournage efficace
- refroidissement optimal grâce à des buses de pulvérisation à bille haute pression réglables
- avec ECO / direct coolant
- Transfert de liquide de refroidissement vers la queue de l'outil
- * Plaque de rondelle pour arbre 20x20 non comprise dans la livraison

Werkzeughalter axial

Tool holder axial

Porte-outil axial

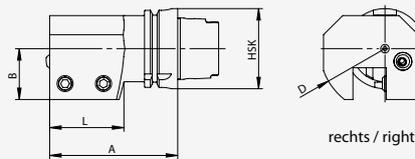

Bestell-Nr. / Order number/ Code	HSK	B	Vier- kant Square	A	L	ØD	kg		
HA4.V16.(R/L)11.080	T40	30	16x16	80	40	80	1.04	NI4.026.010.020	KU1.U12.001.010
HA4.V20.(R/L)11.080	T40	30	20x20	80	45	80	1.04	NI4.026.012.025	KU1.U12.001.010
HA6.V20.(R/L)11.090	T63	30	20x20	90	45	80	1.68	NI4.026.010.020	KU1.U12.001.010
HA6.V25.(R/L)11.100	T63	40	25x25	100	58	102	1.68	NI4.026.010.020	KU1.U12.001.010
HA0.V25.(R/L)11.125	T100	50	25x25	125	80	122	2.20	NI4.026.010.020	KU1.U12.001.010
HA0.V32.(R/L)11.125	T100	50	32x32	125	80	122	3.47	NI4.026.012.030	KU1.U12.001.010

**Werkzeughalter axial doppelt
mit ECO / Direct Coolant**

**Tool holder axial double
with ECO / direct coolant**

**Porte-outil axial double
ECO / direct coolant**

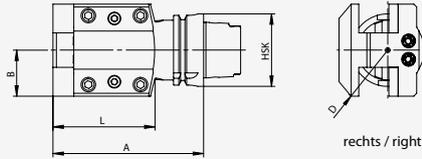

Bestell-Nr. / Order number/ Code	HSK	B	Vier- kant Square	A	L	ØD	kg					
HA6.V2X.R21.130-HP	T63	40	25x25 20x20*	130	88	100	2.90	KU1.U12.002.010	V2X.ER1.025.066	V2X.ER2.025.082(R) V2X.ER1.025.082(L)	NI4.762.006.016	NI4.762.006.016

- für effiziente Drehbearbeitung
- optimale Kühlung durch einstellbare Hochdruck Kugelspritzdüsen
- mit ECO / direct coolant
- Kühlmittelübergabe zum Werkzeugschaft
- * Unterlegplatte für Schaft 20x20 nicht im Lieferumfang enthalten

- to turn efficiently
- optimal cooling through adjustable high pressure ball spray nozzles
- with ECO / direct coolant
- coolant transfer into tool shank
- * shim for shaft 20x20 not included in delivery

- pour un tournage efficace
- refroidissement optimal grâce à des buses de pulvérisation à bille haute pression réglables
- avec ECO / direct coolant
- Transfert de liquide de refroidissement vers la queue de l'outil
- * Plaque de rondelle pour arbre 20x20 non comprise dans la livraison

Werkzeughalter axial doppelt

Tool holder axial double

Porte-outil axial double

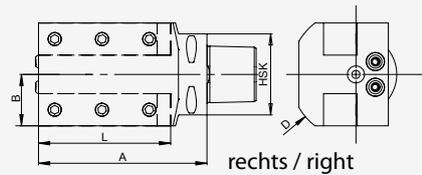

Bestell-Nr. / Order number/ Code	HSK	B	Vier- kant Square	A	L	ØD	kg		
HA4.V20.R21.080	T40	30	20x20	80	45	80	1.14	NI4.026.010.020	KU1.U12.001.010
HA6.V20.R21.090	T63	30	20x20	90	45	80	1.95	NI4.026.010.020	KU1.U12.001.010
HA6.V25.R21.100	T63	40	25x25	100	58	102	3.22	NI4.026.010.025	KU1.U12.001.010
HA0.V25.R21.125	T100	50	25x25	125	80	122	6.78	NI4.026.012.025	KU1.U12.001.010
HA0.V32.R21.125	T100	50	32x32	125	80	122	6.45	NI4.026.012.025	KU1.U12.001.010

Werkzeughalter axial dreifach

Tool holder axial triple

Porte-outil axial triple

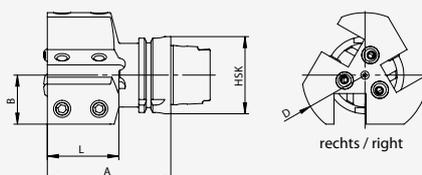

Bestell-Nr. / Order number/ Code	HSK	B	Vier- kant Square	A	L	ØD	kg		
HA6.V20.R31.090	T63	30	20x20	90	45	90	1.90	NI4.026.010.025	KU1.U12.001.010
HA6.V25.R31.100	T63	40	25x25	100	58	102	2.85	NI4.026.012.020	KU1.U12.001.010
HA0.V25.R31.125	T100	50	25x25	125	80	122	7.30	NI4.026.012.020	KU1.U12.001.010

**Werkzeughalter diagonal 45°
mit ECO / Direct Coolant**

**Tool holder diagonal 45°
with ECO / direct coolant**

**Porte-outil diagonal 45°
ECO / direct coolant**

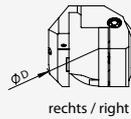
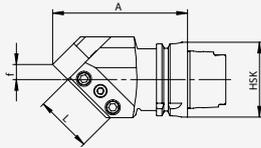

Bestell-Nr. / Order number/ Code	HSK	f	Vier- kant Square	A	ØD	R/L	kg					
HA6.V2X.R12.110-HP	T63	15	25x25 20x20*	110	94	R	1.87	NI4.026.012.016	KU1.U12.002.010	V2X.ER1.025.061	V2X.ER2.025.079	NI4.762.006.016
HA6.V2X.L12.110-HP	T63	15	25x25 20x20*	110	94	L	1.87	NI4.026.012.016	KU1.U12.002.010	V2X.ER1.025.061	V2X.ER2.025.079	NI4.762.006.016

- für effiziente Drehbearbeitung
- optimale Kühlung durch einstellbare Hochdruck Kugelspritzdüsen
- mit ECO / direct coolant
- Kühlmittelübergabe zum Werkzeugschaft
- * Unterlegplatte für Schaft 20x20 nicht im Lieferumfang enthalten

- to turn efficiently
- optimal cooling through adjustable high pressure ball spray nozzles
- with ECO / direct coolant
- coolant transfer into tool shank
- * shim for shaft 20x20 not included in delivery

- pour un tournage efficace
- refroidissement optimal grâce à des buses de pulvérisation à bille haute pression réglables
- avec ECO / direct coolant
- Transfert de liquide de refroidissement vers la queue de l'outil
- * Plaque de rondelle pour arbre 20x20 non comprise dans la livraison

Werkzeughalter diagonal 45°

Tool holder diagonal 45°

Porte-outil diagonal 45°

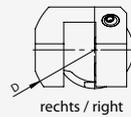
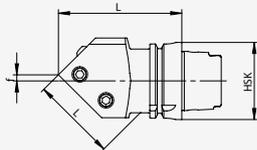

Bestell-Nr. / Order number/ Code	HSK	f	Vier- kant Square	A	ØD	R/L	kg		
HA4.V20.R12.080	T40	5	20x20	80	80	R	0.84	NI4.026.010.025	KU1.U12.001.010
HA4.V20.L12.080	T40	5	20x20	80	80	L	0.84	NI4.026.010.025	KU1.U12.001.010
HA6.V20.R12.100	T63	5	20x20	100	80	R	1.80	NI4.026.010.025	KU1.U12.001.010
HA6.V20.L12.100	T63	5	20x20	100	80	L	1.80	NI4.026.010.025	KU1.U12.001.010
HA6.V25.R12.100	T63	5	25x25	100	102	R	2.10	NI4.026.010.025	KU1.U12.001.010
HA6.V25.L12.100	T63	5	25x25	100	102	L	2.10	NI4.026.010.025	KU1.U12.001.010
HA0.V25.R12.125	T100	5	25x25	125	122	R	5.60	NI4.026.010.025	KU1.U12.001.010
HA0.V25.L12.125	T100	5	25x25	125	122	L	5.60	NI4.026.010.025	KU1.U12.001.010

Verlängerung

Extension

Extension

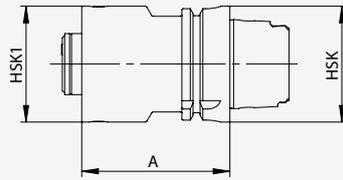

Bestell-Nr. / Order number/ Code	HSK	HSK 1	A	kg	Dichtring / Sealing ring	Spannpatrone / Clamping cartridge	Verschlusschraube / Drive bolt
HA4.HA4.K01.060	T40	T40	60	0.50	HA4.ER4.004.006	HA4.ER1.001.000	HA4.ER2.001.005
HA4.HA4.K01.080	T40	T40	80	0.70	HA4.ER4.004.006	HA4.ER1.001.000	HA4.ER2.001.005
HA6.HA6.K01.080	T63	T63	80	1.70	HA6.ER4.004.008	HA6.ER1.001.000	HA6.ER2.001.007
HA6.HA6.K01.120	T63	T63	120	2.65	HA6.ER4.004.008	HA6.ER1.001.000	HA6.ER2.001.007
HA6.HA6.K01.240	T63	T63	240	5.20	HA6.ER4.004.008	HA6.ER1.001.000	HA6.ER2.001.007
HA6.HA6.K01.280	T63	T63	280	6.20	HA6.ER4.004.008	HA6.ER1.001.000	HA6.ER2.001.007
HA6.HA6.K01.350	T63	T63	350	7.80	HA6.ER4.004.008	HA6.ER1.001.000	HA6.ER2.001.007
HA0.HA0.K01.125	T100	T100	125	6.90	HA0.ER4.004.010	HA0.ER1.001.000	HA0.ER2.001.000
HA0.HA0.K01.160	T100	T100	160	9.00	HA0.ER4.004.010	HA0.ER1.001.000	HA0.ER2.001.000
HA0.HA0.K01.200	T100	T100	200	10.30	HA0.ER4.004.010	HA0.ER1.001.000	HA0.ER2.001.000

Reduktion

Reduction

Réduction

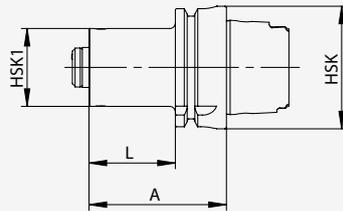

Bestell-Nr. / Order number/ Code	HSK	HSK 1	L	A	kg	Dichtring / Sealing ring	Spannpatrone / Clamping cartridge	Verschlusschraube / Drive bolt
HA6.HA4.K01.070	T63	T40	44	70	1.20	HA4.ER4.004.006	HA4.ER1.001.000	HA4.ER2.001.005
HA0.HA4.K01.080	T100	T40	51	80	2.60	HA4.ER4.004.006	HA4.ER1.001.000	HA4.ER2.001.005
HA0.HA6.K01.100	T100	T63	71	100	3.60	HA6.ER4.004.008	HA6.ER1.001.000	HA6.ER2.001.007
HA0.HA6.K01.150	T100	T63	121	150	4.30	HA6.ER4.004.008	HA6.ER1.001.000	HA6.ER2.001.007

Trennstellenverschluss

Blanking plug

Bouchon d'ébauche

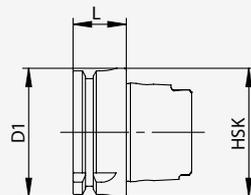

Bestell-Nr. / Order number/ Code	HSK	D1	L	kg
HA4.000.001.020	T40	40	20	0.19
HA6.000.001.026	T63	63	26	0.64
HA0.000.001.029	T100	100	29	2.04

Spanneinheit HSK

Clamping unit HSK

Unité de serrage HSK

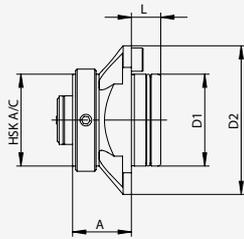

Bestell-Nr. / Order number / Code	HSK-8	D1	D2	A	L	kg	Dichtring / Sealing ring	Spannpatrone / Clamping cartridge	Verschlusschraube / Drive bolt
U40.HA4.001.025	40	40	68	25	17	0.50	HA4.ER4.004.006	HA4.ER1.001.000	HA4.ER2.001.005
U63.HA6.001.040	63	63	102	40	20	1.75	HA6.ER4.004.008	HA6.ER1.001.000	HA6.ER2.001.007
U10.HA0.001.060	100	100	165	60	30	4.65	HA0.ER4.004.010	HA0.ER1.001.000	HA0.ER2.001.000

Rohling

Blank

Ébauche

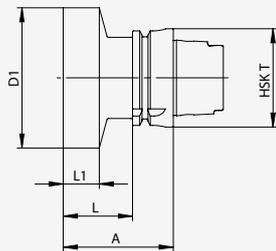

Bestell-Nr. / Order number / Code	HSK	D1	A	L	L1	kg
HA4.Ro4.001.055	T40	54	55	35	20	0.70
HA6.Ro5.001.100	T63	52	100	-	58	4.75
HA6.Ro9.001.070	T63	90	70	44	28	0.53
HA6.Ro6.001.200	T63	63	200	174	158	4.93
HA0.Ro8.001.125	T100	87	125	-	80	6.47
HA0.Ro0.001.090	T100	130	90	61	45	7.25
HA0.Ro0.001.250	T100	100	250	221	205	15.5

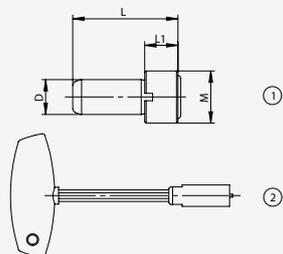
Kühlmittelrohr
MontageschlüsselCoolant tube
assembling keyClé de montage
du tube d'arrosage

Bestell-Nr. / Order number / Code	HSK	M	Typ
HA4.ER4.001.030	40	12x1	1
HA4.ER4.002.115	40		2
HA6.ER4.001.036	63	18x1	1
HA6.ER4.002.136	63		2
HA0.ER4.001.044	100	24x1.5	1
HA0.ER4.002.136	100		2

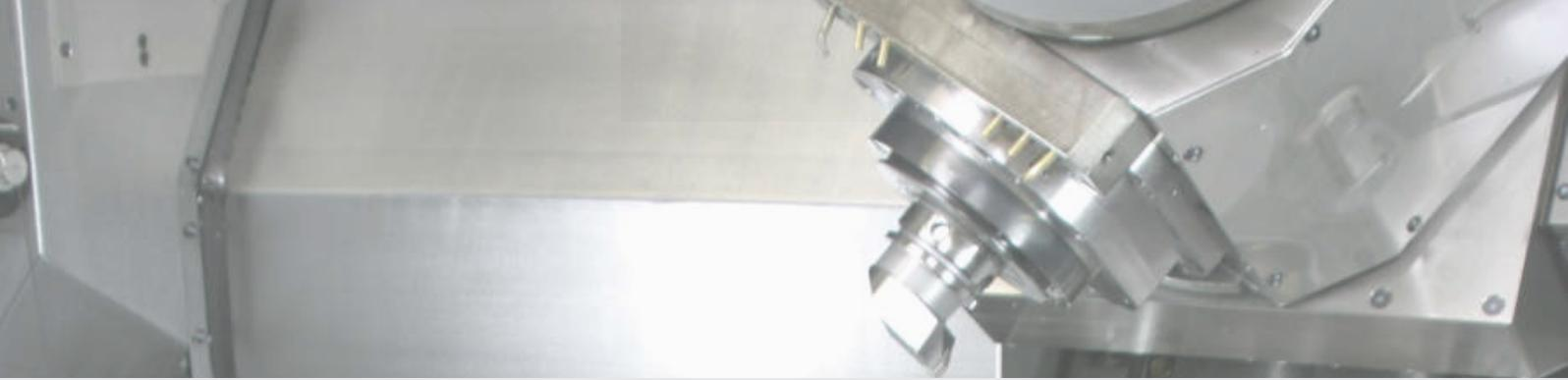

QUICK-CHANGE Werkzeugsysteme
für Multi-Task und Drehmaschinen

QUICK-CHANGE tool system for
multi-tasking and turning lathes

QUICK-CHANGE système pour tours
et pour centre de tournage/fraisage

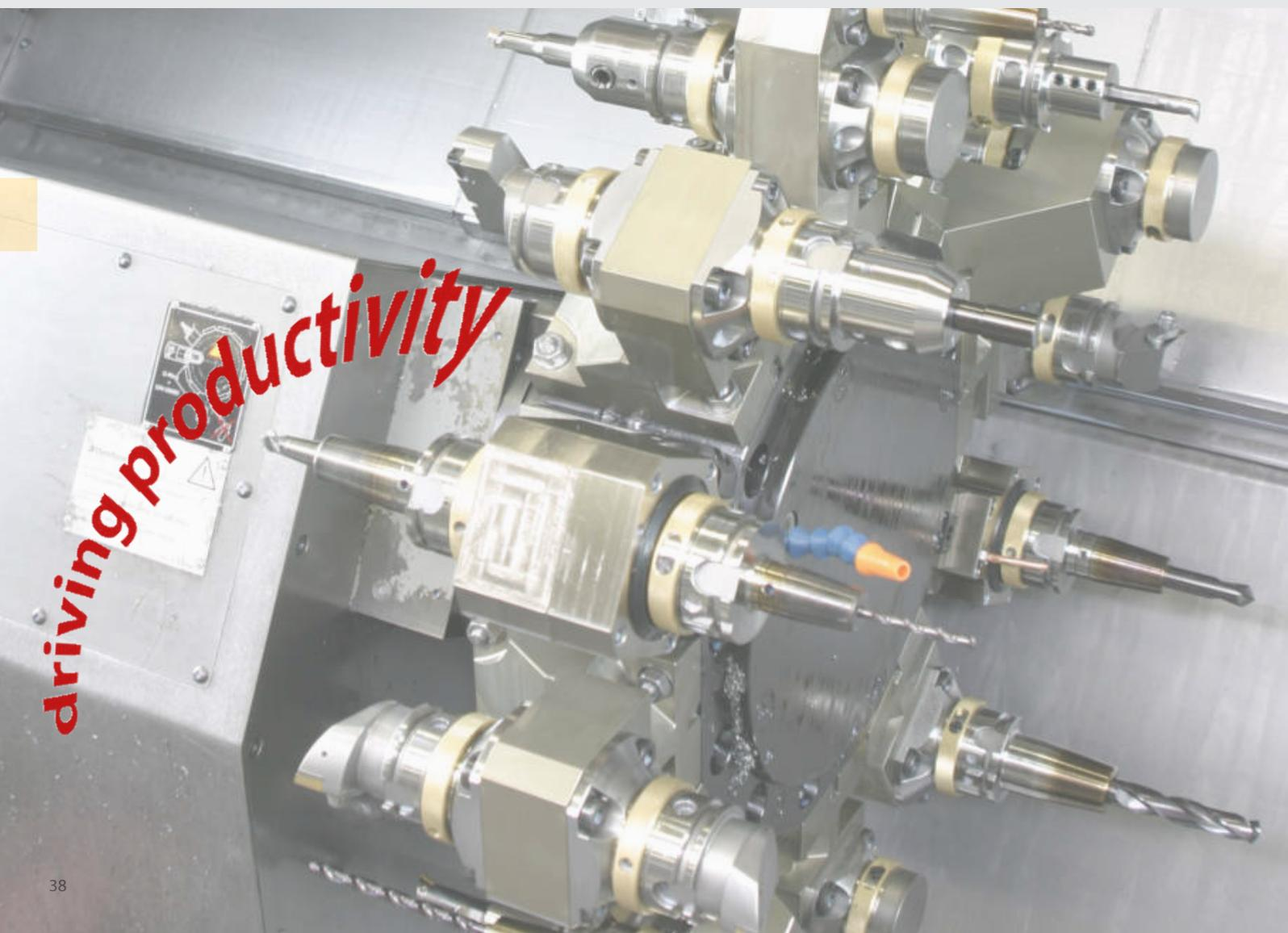
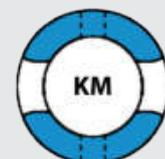

driving productivity

Systemlösungen / System solution / Solution de système

- Produktivitätssteigerung durch Reduktion der Nebenzeiten.
- Werkzeugwechsel in kürzester Zeit
- Beste Wiederholgenauigkeit mit definierten, gleichbleibenden Werkzeugkonturen
- Für alle Maschinentypen geeignet.
- Flexibel für HSK, PSC und KM Werkzeuge
- Kosteneffizient System

- Increase productivity by reducing non-productive time
- Very quick tool changing time
- Perfect repeatability with fixed tool geometry
- Useable for all machine brands
- Flexible with HSK, PSC and KM tools
- Cost efficient

- Augmenter la productivité en réduisant le temps de non-production.
- Temps de changement d'outil très rapide
- Répétabilité parfaite avec une géométrie d'outil fixe
- Convient à tous les types de machines
- Flexible avec les outils HSK, PSC et KM
- Système rentable



- Online Konfigurator
- Angetriebene- und statische Werkzeuge für Drehmaschinen
- www.swisstools.org

- Online configurator
- for static and rotating tools
- www.swisstools.org

- Configurateur online
- pour les outils statiques et tournants
- www.swisstools.org

Adaptionsmöglichkeiten Drehrevolverscheiben / Adaptation to turrets / Adaptation à la tourelle

Werkzeughalter mit Schnellwechselsystem

Das Werkzeughalterprogramm umfasst innovative und technisch ausgereifte Lösungen für alle gängigen CNC-Drehzentren. Wir bieten Ihnen Lösungen, die optimal auf das Maschinenfabrikat abgestimmt sind, ob mit BMT/ VDI oder anderen Anbindungen. Die Schnittstelle des Schnellwechselsystems ist DIN/ISO normiert, und für die Größen HSK 40/63/100, PSC40/50/63 und KM 40/50/63 vorhanden. Der Werkzeugwechsel ist einfach und schnell durchführbar. Die Nebenzeiten werden minimiert und damit die Produktivität gesteigert.

Tool holder with QUICK-CHANGE system

The whole range of the system contains solutions for the most CNC lathes centres. Complementary on the machine tool with BMT / VDI or other connections. The tool connection is based on DIN/ISO standards with HSK 40/63/100, PSC40/50/63 and KM 40/50/63. The tool change is very simple and quick. Non-productive times are minimized and the productivity will increase.

Porte-outil avec système de changement rapide

Le programme de porte-outils comprend des solutions innovantes et techniquement sophistiquées pour tous les centres de tournage CNC courants. Nous vous proposons des solutions, adaptées de manière optimale à la marque de la machine, que ce soit avec des connexions BMT/ VDI ou autres. L'interface du système de changement rapide est normalisée DIN/ISO et disponible pour les tailles HSK 40/63/100, PSC40/50/63 et KM 40/50/63. Le changement d'outil peut être effectué facilement et rapidement. Le temps de non-productivité sera minimisé et la productivité est ainsi augmentée.



Werkzeughalter / Tool holders / Porte-outils

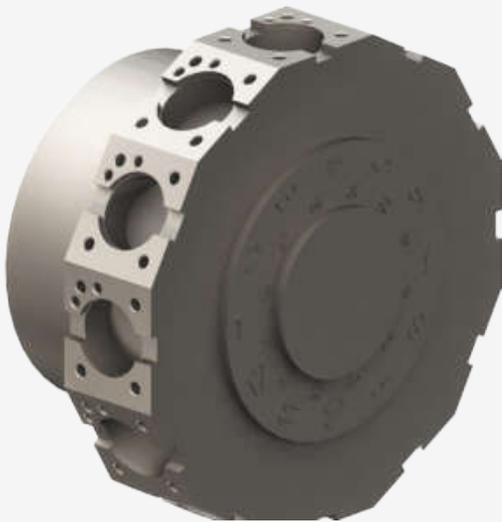

Revolverscheibe /
Turret/ Tourelle
BMT/VDI/...



Werkzeughalter
einfach gerade

Tool holder
single straight

Porte-outils
single droit



Werkzeughalter
doppelt gerade

Tool holder
double straight

Porte-outils
double droit



Werkzeughalter
einfach abgewinkelt

Tool holder
single angular

Porte-outils
single angulaire



Werkzeughalter
doppelt abgewinkelt

Tool holder
double angular

Porte-outils
double angulaire

HSK / PSC / KM Spanneinheiten / HSK / PSC / KM clamping unit / HSK / PSC / KM unités de serrage

Die Werkzeughalter werden entweder mit einer HSK oder einer PSC Spanneinheit ausgerüstet.

Die Werkzeughalter sind somit flexibel auf die Kundenbedürfnisse anpassbar.

Spanneinheiten sind in den Größen HSK 40/63/100, PSC40/50/63 und KM 40/50/63 erhältlich

Tool holders are equipped with HSK or PSC clamping units.

Very flexible for customer needs.

Clamping units are available in HSK 40/63/100, PSC40/50/63 and KM 40/50/63.

Les porte-outils sont soit équipés d'unités de serrage HSK ou PSC.

Les porte-outils sont par conséquent très flexible pour le besoin du client.

Les unités de serrage sont disponibles en HSK 40/63/100, PSC40/50/63 et KM 40/50/63.

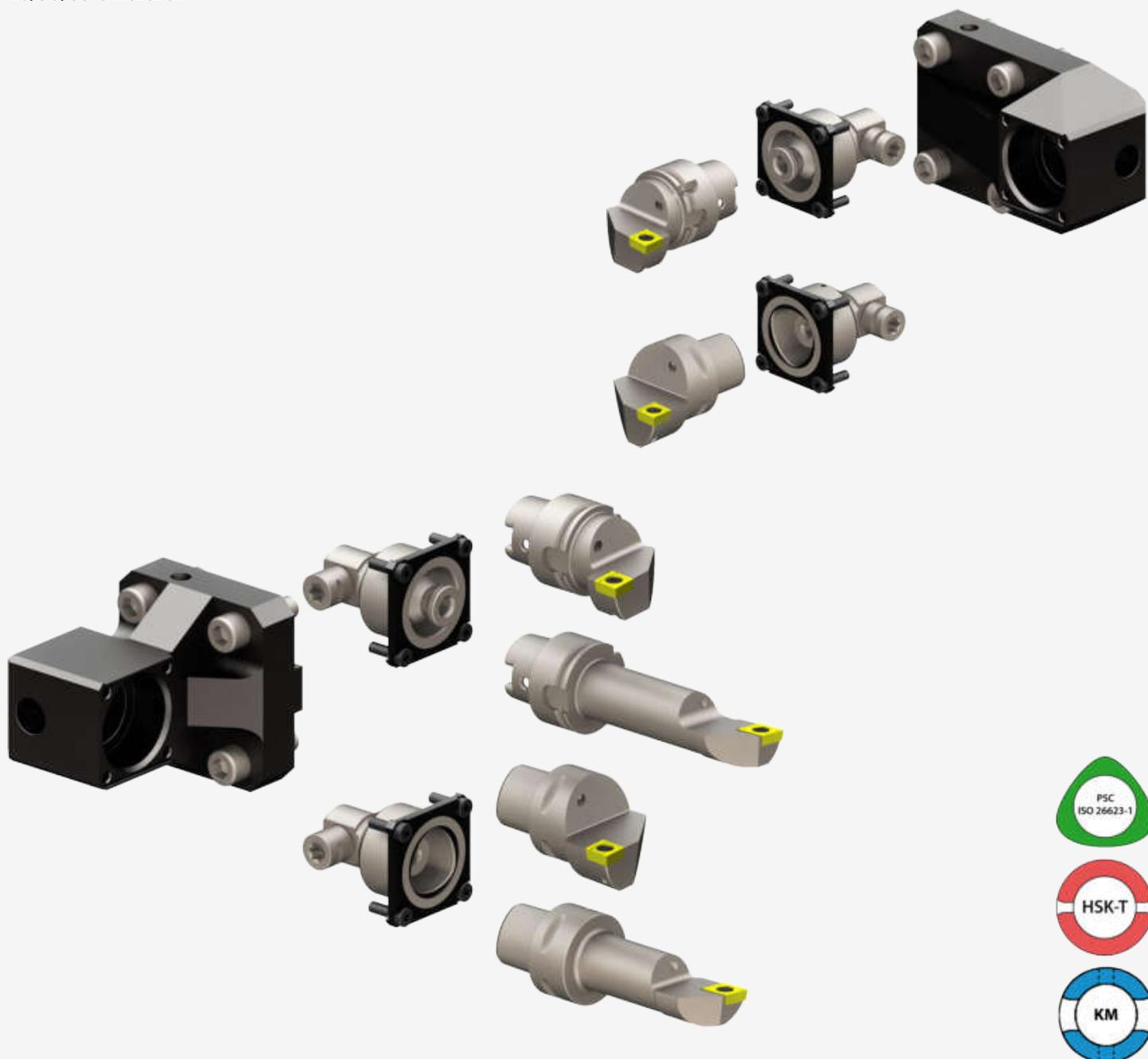

Quick-Change Werkzeughalter und Spanneinheiten

Quick-Change Toolholders and clamping units

Porte-outils et unités de serrage à changement rapide

Werkzeughalter mit VDI Schaft abgewinkelt / DIN 69880

Toolholder with VDI shank angular / DIN 69880

Porte-outils avec tige VDI angulaire / DIN 69880

- Schaft mit Doppelverzahnung R/L Einsatz möglich
- für Innenkühlung

- shank with double serration profile R/L usage possible
- for inner coolant supply

- tige avec double denture, utilisation G/D possible
- pour le arrosage interne

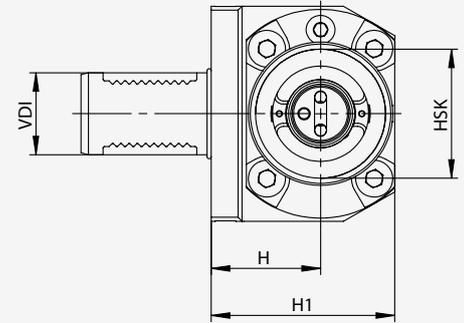
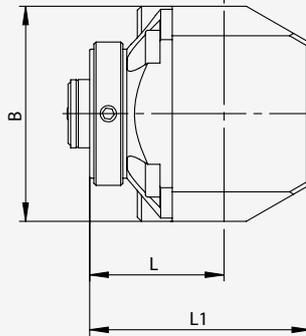
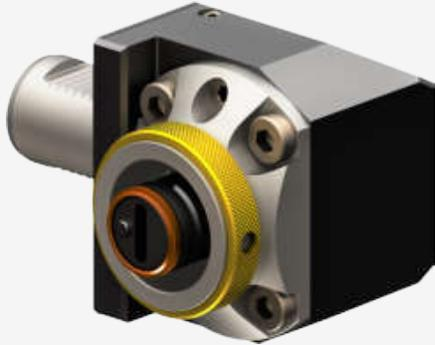

Bestell-Nr. / Order number/ Code	HSK	H	H1	VDI	L	L1	B	kg
REA.HA4.VD3.041-11	T40	41	63	30	32	62	68	
REA.HA4.VD4.051	T40	51	75	40	34	90	75	
REA.HA6.VD4.053	T63	53	95	40	45	85	105	
REA.HA6.VD5.055	T63	55	97	50	45	85	105	

Werkzeughalter mit VDI Schaft gerade / DIN 69880

Toolholder with VDI shank straight / DIN 69880

Porte-outils avec tige VDI droite / DIN 69880

- Schaft mit Doppelverzahnung R/L Einsatz möglich
- für Innenkühlung

- shank with double serration profile R/L usage possible
- for inner coolant supply

- tige avec double denture, utilisation G/D possible
- pour le arrosage interne

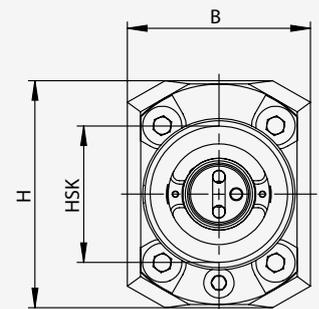
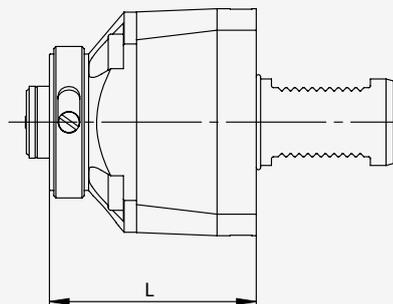
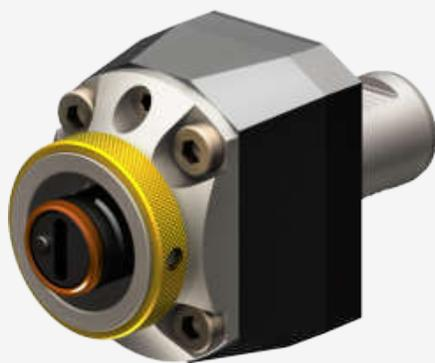

Bestell-Nr. / Order number/ Code	HSK	L	H	VDI	B	kg
RER.HA4.VD3.065-11	T40	65	68	30	52	
RER.HA4.VD3.074	T40	74	60	30	52	
RER.HA4.VD4.079	T40	79	75	40	75	
RER.HA6.VD4.095-11	T63	95	105	40	84	
RER.HA6.VD5.105-11	T63	105	105	50	84	
RER.HA6.VD6.105-11	T63	105	105	60	84	

Quadratischer Schaft

- Anschluss für Innenkühlung



Rectangular shank

- Coupling for inner coolant supply

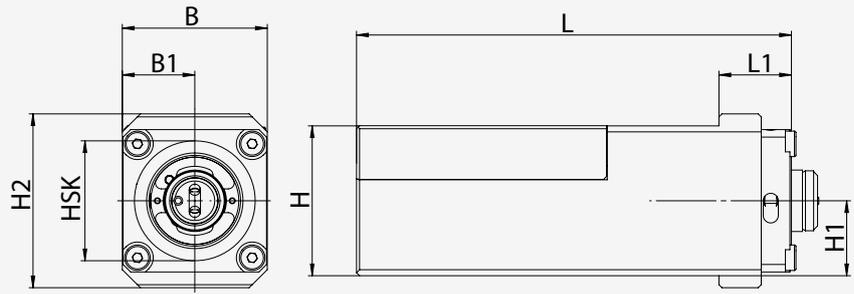

Porte-outils rectangulaire

- Raccordement pour l'arrosage interne

Bestell-Nr. / Order number / Code	HSK	B	B1	H	H1	H2	L	L1	kg
RER.HA4.V20.144	T40	48	24	40	20	58	144	54	
RER.HA4.V25.144	T40	48	24	50	25	58	144	61	
RER.HA4.V32.139	T40	48	24	64	32	64	139	56	



Ersatzteile / Zubehör

Spare parts / Accessories

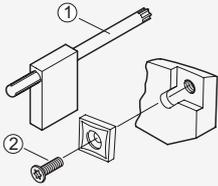

Für Klemmhalter/
Bohrstange
For turning tool/
boring bar

Typ/
Type Bestell-Nr. / ^①
Order number Bestell-Nr. / ^②
Order number

		Torx-Schlüssel/ Torx driver	Torx-Schraube Torx screw (Nm)
xxx.xCC.xxx.xxx	S01	WCC.ER1.001.000	WCC.ER2.001.010 (5.0 Nm)
xxx.xCD.xxx.xxx	S02	WCC.ER1.001.000	WCC.ER2.001.010 (5.0 Nm)
xxx.xCE.xxx.xxx	S03	WCE.ER1.001.000	WCE.ER2.001.012 (5.0 Nm)
xxx.xWE.xxx.xxx	S04	WCC.ER1.001.000	WCC.ER2.001.010 (5.0 Nm)
xxx.xDB.xxx.xxx	S05	WCB.ER1.001.000	WCB.ER2.001.009 (3.0 Nm)
xxx.xDF.xxx.xxx	S06	WCC.ER1.001.000	WCC.ER2.001.010 (5.0 Nm)
xxx.xVF/VB.xxx.xxx	S07	WCB.ER1.001.000	WCB.ER2.001.009 (3.0 Nm)
xxx.xVD.xxx.xxx	S08	WCB.ER1.001.000	WCB.ER2.001.009 (3.0 Nm)
xxx.xSB.xxx.xxx	S09	WCC.ER1.001.000	WCC.ER2.001.010 (5.0 Nm)
xxx.xVE/VA.xxx.xxx	S10	WCA.ER1.001.000	WCA.ER2.001.006 (0.9 Nm)

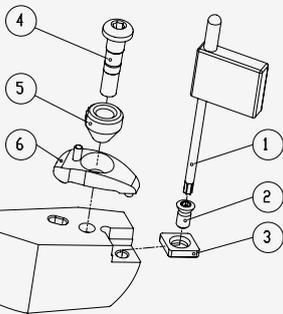

Für Klemmhalter/
Bohrstange
For turning tool/
boring bar

Typ/
Type Bestell-Nr. / ^③
Order number Bestell-Nr. / ^④
Order number Bestell-Nr. / ^⑤
Order number Bestell-Nr. / ^⑥
Order number

		Zwischenlage/ Tip pad	Spannschraube/ Clamping screw (Nm)	Düsenring/ Nozzle ring	Spannpratze/ Clamping short
xxx.xCD.xxx.xxx	D01	WCD.ER2.101.003	WCC.ER4.103.032 (10 Nm)	WCC.ER5.102.012	WCC.ER3.102.024
xxx.KCE.R/Lxx.xxx	D02	WCE.ER2.101.004	WCC.ER4.103.032 (10 Nm)	WCC.ER5.102.012	WCC.ER3.102.024
xxx.KCE.Nxx.xxx	D03	WCE.ER2.101.004	WCC.ER4.103.032 (10 Nm)	WCC.ER5.102.012	WCC.ER3.102.029
xxx.KWE.R/Lxx.xxx	D04	WWE.ER2.101.004	WCC.ER4.103.032 (10 Nm)	WCC.ER5.102.012	WCC.ER3.102.024
xxx.xDF.R/Lxx.xxx	D05	WDF.ER2.101.003	WCC.ER4.103.032 (10 Nm)	WCC.ER5.102.012	WCC.ER3.102.024
xxx.KDF.Nxx.xxx	D06	WDF.ER2.101.003	WCC.ER4.103.032 (10 Nm)	WCC.ER5.102.012	WCC.ER3.102.029
xxx.xVD.R/Lxx.xxx	D07	WVD.ER2.101.003	WCC.ER4.103.032 (10 Nm)	WCC.ER5.102.012	WCC.ER3.102.024
xxx.KVD.Nxx.xxx	D08	WVD.ER2.101.003	WCC.ER4.103.032 (10 Nm)	WCC.ER5.102.012	WCC.ER3.102.029
xxx.KSD.R/Lxx.xxx	D09	WSD.ER2.101.003	WCC.ER4.103.032 (10 Nm)	WCC.ER5.102.012	WCC.ER3.102.024

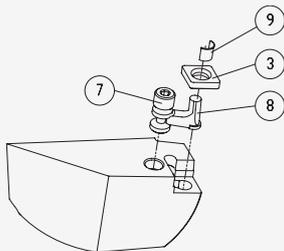

Für Klemmhalter/
Bohrstange
For turning tool/
boring bar

Typ/
Type Bestell-Nr. / ^⑦
Order number Bestell-Nr. / ^⑧
Order number Bestell-Nr. / ^⑨
Order number

		Zwischenlage/ Tip pad	Spannschraube/ Clamping screw	Kniehebel/ Lever	Rohrstift/ Hollow pin
xxx.PCD.xxx.xxx	P01	WCD.ER2.101.003	WCD.ER4.101.017 (5.0 Nm)	WCD.ER3.101.000	WCD.ER1.101.000
xxx.PCE.R/Lxx.xxx	P02	WCE.ER2.101.004	WCE.ER4.101.004 (5.0 Nm)	WCE.ER3.101.000	WCE.ER1.101.000
xxx.PCE.Nxx.xxx	P03	WCE.ER2.101.004	WCE.ER4.101.004 (5.0 Nm)	WCE.ER3.101.000	WCE.ER1.101.000
xxx.PWE.R/Lxx.xxx	P04	WWE.ER2.101.004	WCD.ER4.101.017 (5.0 Nm)	WDF.ER3.101.000	WCD.ER1.101.000
xxx.PDF.R/Lxx.xxx	P05	WDF.ER2.101.003	WCD.ER4.101.017 (5.0 Nm)	WDF.ER3.101.000	WCD.ER1.101.000
xxx.PDF.Nxx.xxx	P06	WDF.ER2.101.003	WCD.ER4.101.017 (5.0 Nm)	WDF.ER3.101.000	WCD.ER1.101.000
xxx.PSD.R/Lxx.xxx	P07	WSD.ER2.101.003	WCD.ER4.101.017 (5.0 Nm)	WCD.ER3.101.000	WCD.ER1.101.000
xxx.PDE.xxx.xxx.xxx	P08	WDE.ER2.101.003	WDE.ER4.101.017 (5.0 Nm)	WDE.ER3.101.000	WDE.ER1.101.000
xxx.PCF.xxx.xxx	P09	WCF.ER2.101.000	WCF.ER4.101.027 (9.0 Nm)	WCF.ER3.101.000	WCF.ER1.101.000
xxx.PSE.xxx.xxx	P10	WSE.ER2.101.004	WCE.ER4.101.004 (5.0 Nm)	WCE.ER3.101.000	WCE.ER1.101.000

Für Werkzeughalter/
Für Bohrstangenhalter
For tool holder/
For boring bar holder

Bestell-Nr. /
Order number

	Klemmschraube/ Clamping screw (Nm)	Dimension
xxx.V20.xxx.xxx	ERU.GS6.001.018 (15.0 Nm)	M10 x 18
xxx.V25.xxx.xxx	ERU.GS7.001.025 (20.0 Nm)	M12 x 25
xxx.B06.xxx.xxx	ERU.GS4.001.010 (5.0 Nm)	M 6 x 10
xxx.B08...B12.xxx.xxx	ERU.GS5.001.010 (10.0 Nm)	M 8 x 10
xxx.B16...B40.xxx.xxx	ERU.GS6.001.012 (15.0 Nm)	M10 x 12

Bezeichnung von HSK Klemmhalter für Aussenbearbeitung Identification of external HSK turning tool holder

HSK-T63 | D | C | L | N | R | 45 | 070 | 12
 1 | 2 | 3 | 4 | 5 | 6 | 7 | 8 | 9

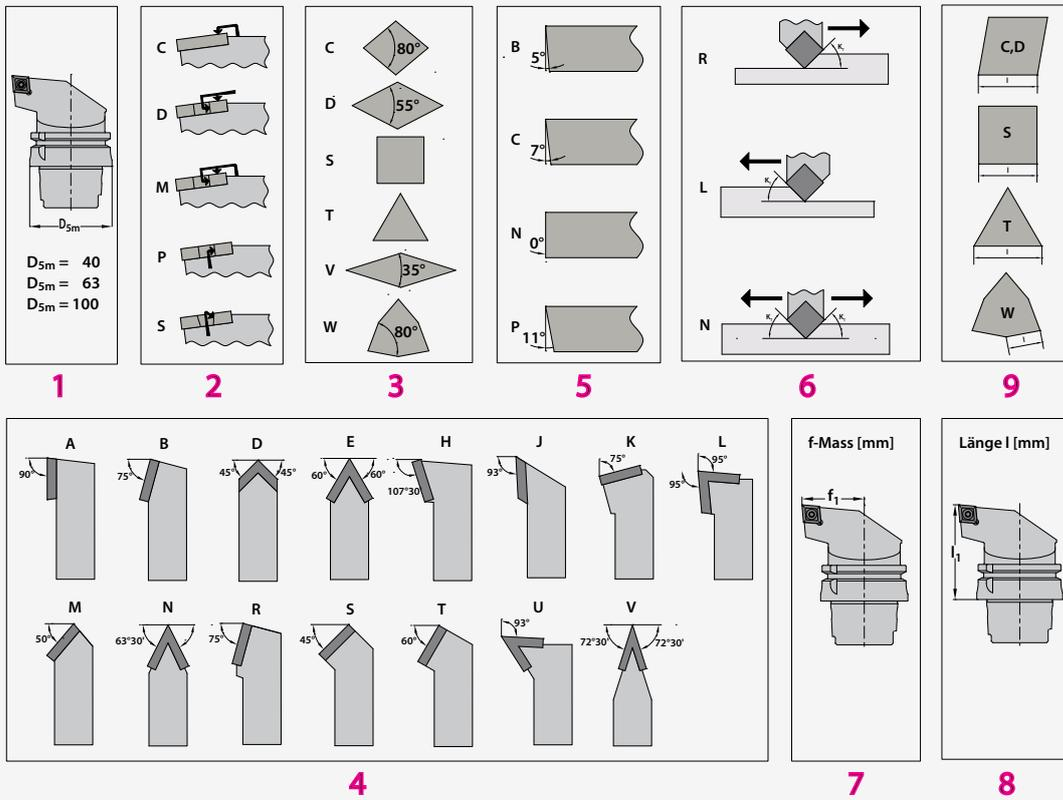

Bezeichnung von HSK Klemmhalter für Innenbearbeitung Identification of external HSK turning tool holder

HSK-T63 | S | C | L | C | R | - | 27180 | - | 09
 1 | 2 | 3 | 4 | 5 | 6 | 7 | 8

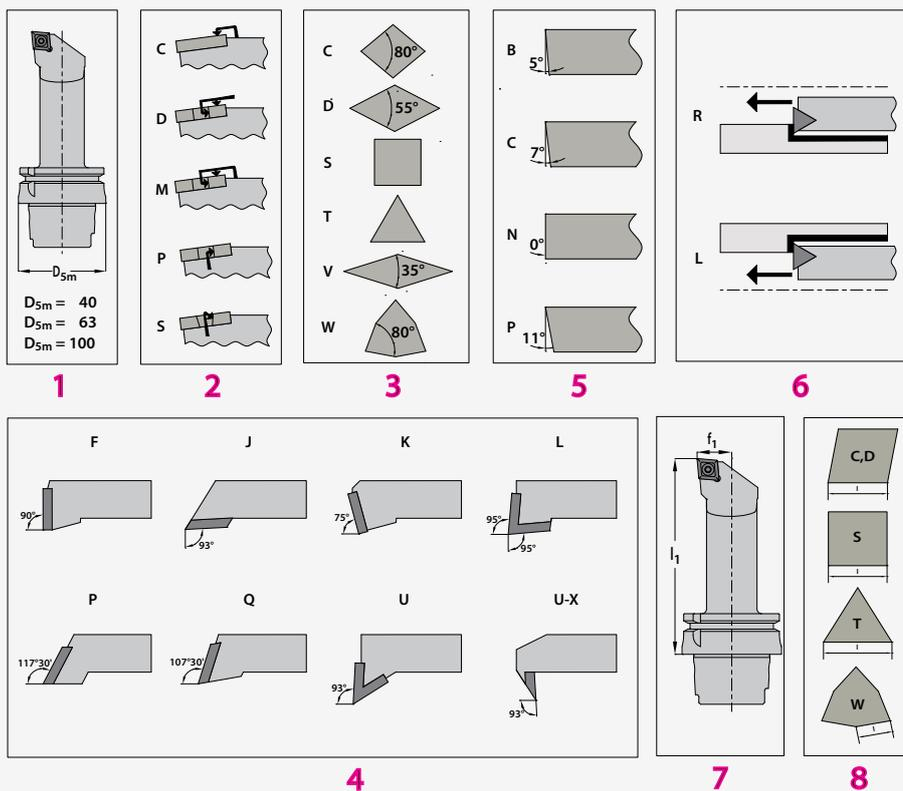





SWISS  **TOOLS**[®]
SCHAUBLIN

Swiss Tool Systems AG
Wydenstrasse 28
CH-8575 Bürglen
Phone +41 (0)71 634 85 20
Fax +41 (0)71 634 85 29
www.swisstools.org